

CHRISTMAS £4 TWO-VALVER COMPLETE WITH VALVES, BATTERIES AND MOVING-COIL LOUDSPEAKER

Wireless Magazine

DECEMBER
1934

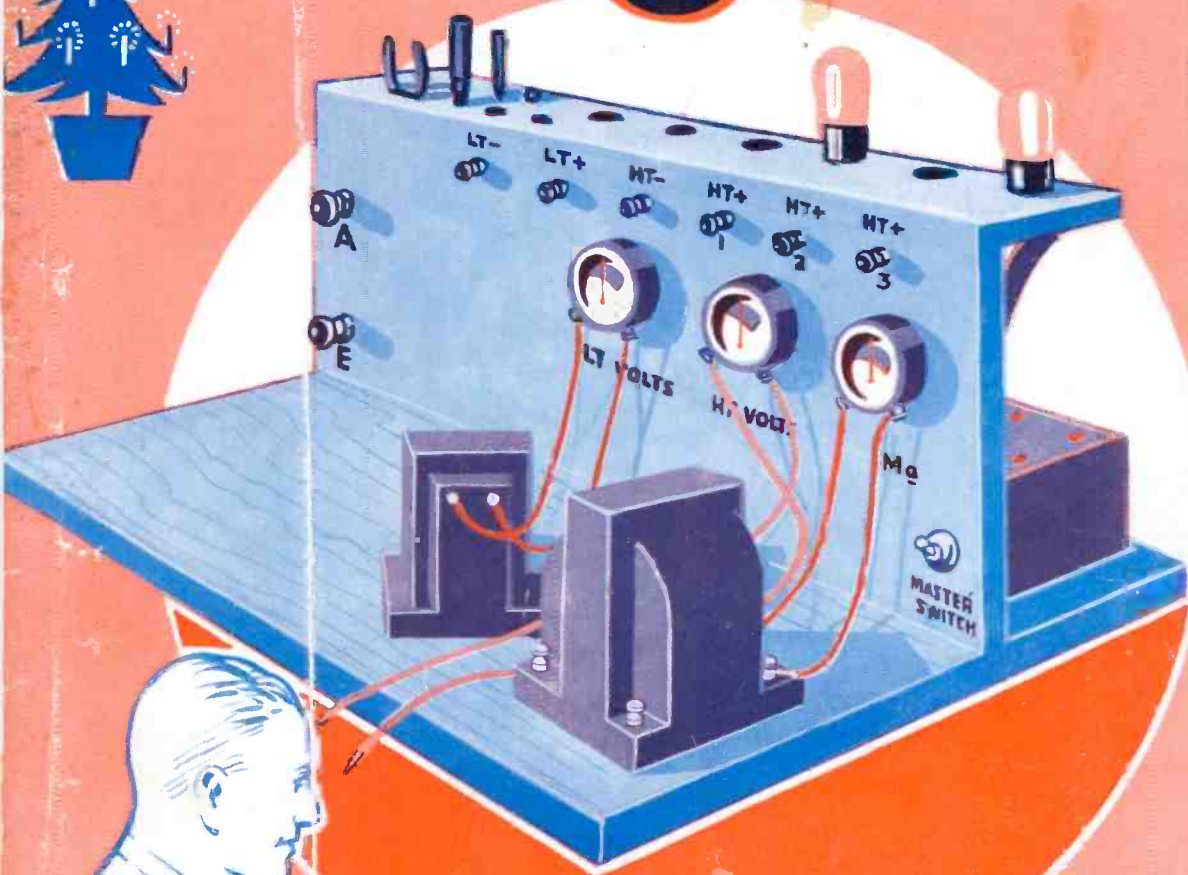

PARTY PRANKS
with YOUR RADIO

DE-LUXE
D.C. THREE

NEW REGIONAL
SCHEME

A TRANSPORTABLE
STENODE?

SOMETHING NEW
IN DETECTORS

READING PICK-UP
RESPONSE CURVES

TRIODES Versus
PENTODES

SHORT-WAVE
DESIGN

HOW TO START EXPERIMENTING



Give Your Set a Tonic!



What a Power of Difference a New **DETECTOR VALVE** will make in **Sensitivity, Selectivity and Quality of Reproduction**

The majority of broadcast receivers prior to 1933 used a Triode Detector. This valve may be said to be the 'key' stage in the set as upon its proper functioning depends the sensitivity, selectivity, quality of reproduction and general absence of background noise so essential to the correct working of a set.

SENSITIVITY and SELECTIVITY

A falling off in the range of a set or flattening of the tuning may be due to weakening of the electron emission from the Detector Valve filament, or poor vacuum in the valve. Modern OSRAM Detector Valves are made with greater emission reserve and devices which ensure the highest possible vacuum.

Do not put up with inferior reception when your set can be so much improved by fitting a new OSRAM Detector Valve. There is a type for every class of broadcast receiver.

Osram Valves

MADE IN ENGLAND

Sold By All Radio Dealers.

A TONIC TO ANY SET

OSRAM DETECTOR TRIODES

HL2	For 2-volt Battery Sets or HL2/K	5/6
HL210	For old type "5-valve" portable	5/6
H210	For OSRAM "MUSIC MAGNET" FOUR and OSRAM "FOUR" Sets	5/6
MH4	For A.C. Mains Sets or Catkin M H 4	13/6
DH	For 0.25 amp. D.C. Mains Sets	13/6

WRITE for the OSRAM VALVE GUIDE (1934 Edition). Sent post free.

Editor-in-Chief:
BERNARD E. JONES

Technical Editor:
J. H. REYNER
B.Sc. (Hors.), A.M.I.E.E.

Radiation Editor:
H. CORBISHLEY

Wireless Magazine

The Best Shillingsworth in Radio

Vol. XX : DECEMBER 1934 : No. 119

Editor:
D. SISSON RELPH
Research Consultants:
W. JAMES and
PERCY W. HARRIS
Assistant Editor:
T. F. HENN

Published by BERNARD JONES PUBLICATIONS, LTD., 58/61 Fetter Lane, London, E.C.4. Telephone: Central 4341 (four lines). Telegrams: "Beejapee, Fleet, London." Subscription: Great Britain and abroad, 15s. 6d. a year, post paid (Canada only, 13s. 6d.). Next issue published on Wednesday, December 19.

Our Christmas Dish!

LIKE a good Christmas pudding, this Christmas Number is a mixture of appetising ingredients, each different from the others, but first-class of its kind. We have well boiled the mixture for you—there is nothing raw about it anywhere—and I now have the pleasure of presenting it as our Christmas dish of radio literature.

Sparks, a first-rate name for a man at a Christmas gathering, tells us of "Party Pranks with Your Radio" in a cheerful article recalling some of the old dodges and introducing some of the new ones, such as the "talking paper" and "spook" ideas. You simply must have an article of this kind in a Christmas Number!

If you have a little money to burn, now's the time. We give you test reports of first-rate sets to buy and constructional details of some to build. Fortunately, you won't need very much money if you take the advice given on page 430 of this issue and "Start Radio for £4."

In this article we describe a two-valver which can be built with every accessory—batteries, valves, cabinet, and moving-coil speaker—for the sum of money mentioned. And the set has quality, and it has been thoroughly tested quite close to the London transmitters, in which situation it logged over twenty stations in half an hour or so.

A comparatively few readers, but very insistent ones, want a D.C. three-valver, and from time to time we try to satisfy their demand. Our latest set of this kind, given this month, has a popular circuit with high-frequency pentode, detector and output pentode, and it uses a tuning pack which embodies a three-gang condenser, carefully matched iron-core coils, and all associated switching.

For anybody in search of a good hobby to start at Christmas, we publish Percy Harris's special article, "How to Start Experimenting," showing how to rig up a simple experimental board which is almost a portable laboratory. On the board is a row of terminals con-

nected to high- and low-tension, and grid-bias batteries, and to meters for reading milliamperes, high-tension volts, and accumulator volts.

The portable lab makes provision for a tool rack and component shelf. The article gives two basic circuits to which can be tacked on certain experimental additions, and the author further shows how to pull circuits to pieces so that we can see for ourselves exactly what a design really embodies.

I want you to read what Alan Hunter says about the B.B.C.'s new Regional Scheme. Perhaps you know that if the B.B.C. is satisfied that Droitwich adequately covers the present service areas of London, North and West Nationals, these medium-wave transmitters will be closed at the New Year, but the B.B.C. will have to be very certain that Droitwich provides on the long waves an equally good alternative service.

We are receiving a considerable post on the Stenode sets and are replying to many queries from interested readers. The designer of these sets, Paul Tyers, goes into a question that has been raised by many readers. Could we give a completely self-contained model?

Paul Tyers explains that work on a transportable has been going on for some time, but certain difficulties have to be faced, as he explains in his article.

There are many other ingredients of this Christmas dish that deserve a word, but my space is limited. I will commend to you the article on short-wave design by Kenneth Jowers, and Noel Bonavia-Hunt's "Something New in Detectors," in which he explains that he has realised the necessity of using diode rectification because any other type of detector must inevitably overload on strong signals, but his task was to find out how to make the diode really sensitive to weak inputs and, in addition, how to avoid distortion on those weak inputs. You will be interested in his solution.

And now may I give myself the great pleasure of wishing every reader a Happy Christmas! B.E.J.

FOR THE CONSTRUCTOR

THE DE-LUXE D.C. THREE. Described by the "W.M." Technical Staff	396
STARTING RADIO FOR £4. By the "W.M." Technical Staff	430
TWENTY-THREE STATIONS ON OUR TWO-VALVER	433
THE SUPER SENIOR MODIFICATION	474

TECHNICAL FEATURES

HOW TO START EXPERIMENTING. By Percy W. Harris, M. Inst. Rad. E.	407
IS A TRANSPORTABLE STENODE POSSIBLE? By Paul D. Tyers	411
WHAT YOU SHOULD KNOW ABOUT SHORT-WAVE DESIGN. By Kenneth Jowers	420
SOMETHING NEW IN DETECTORS. By Noel Bonavia Hunt, M.A.	427
READING PICK-UP RESPONSE CURVES. By P. Wilson, M.A.	437
A TEST OF THE MODERN SUPER SENIOR	440
CURING CAR-MADE STATIC. By R. C. Rickard	442
TESTS OF THE NEW SETS. By the "W.M." Set Selection Bureau	443
K.B. AC/DC SUPER-HET	444

Contents

H.M.V. FLUID-LIGHT AUTORADIOGRAM	445
MARCONIPHONE 257 BATTERY SUPER-HET	446
COSSOR MODEL 535 A.C. SUPER-HET	447
R.G.D. RADIOGRAM—MODEL 703	448
THIS IS A SUPER-HET SEASON! By J. H. Reyner, B.Sc., A.M.I.E.E.	449
TESTS OF NEW APPARATUS	452
TRIODES VERSUS PENTODES. By Captain H. J. Round, M.I.E.E.	454
A NEW USE FOR OLD VALVES	456
MICROVOLTS IN YOUR AERIAL	460

GENERAL ARTICLES

WORLD'S BROADCAST WAVELENGTHS	386
IN TUNE WITH THE TRADE. By Fetter Lane	390
RADIO MEDLEY. By BM/Press	393
SET BUILDING STAGE BY STAGE	401
PARTY PRANKS WITH YOUR RADIO. By L. O. Sparks	402
THE B.B.C. PLANS A NEW REGIONAL SCHEME. By Alan Hunter	404

NEWS OF THE SHORT WAVES. By Kenneth Jowers	413
NEWS ABOUT THE CHRISTMAS PROGRAMMES. By T. F. Henn	414
HOW RADIO HELPS THE WORLD'S WORK. By Morton Barr	417
ON THE CREST OF THE WAVES. By Jay Coote	423
WIRELESS JOBS MADE EASY FOR MR. EVERYMAN. By R. W. Hallows	424
IS THERE A CURE FOR ATMOSPHERICS? By G. S. Scott	434
THE MYSTERIES OF STATION FADING. By E. H. Chapman, D.Sc.	457
THE B.B.C.'S ORCHESTRAS AND CHORUSES. By Whitaker-Wilson	470
NEWS FROM ALL QUARTERS	478
COUPONS: INDEX TO ADVERTISERS	480

TELEVISION SECTION

HOW THE CATHODE-RAY TUBE WORKS	464
THE FUTURE OF TELEVISION	466

GRAMO-RADIO FEATURES

CHOOSING YOUR RECORDS. By Whitaker-Wilson	462
RECORDS REVIEWED. By Chopstick	463

IS A TRANSPORTABLE STENODE POSSIBLE?—see page 411

Registered at the General Post Office for transmission by Canadian Magazine Post

Postage on this issue 3d. (inland and abroad.)

World's Broadcast Wavelengths

Stations best received in the British Isles are indicated in bold type. List is corrected up to the time of going to press.

Note: Names in brackets are those of stations from which the greater part of the programmes are taken.

Wave-length	Name of Station	Dial Readings	Country	Wave-length	Name of Station	Dial Readings	Country
14.00	Deal W2XDJ		United States	31.41	Jeløy LCL		Norway
14.49	Buenos Aires LSÝ		Argentina	31.48	Schenectady W2XAF (WGY)		United States
14.58	Bandoeng PMB		Java	31.54	Daventry (Empire) GSB		Great Britain
15.92	Bandoeng PLE		Java	31.55	Melbourne VK3ME		Victoria
16.36	Lawrenceville (N.J.) WLA		United States	31.55	Caracas YV3BC		Venezuela
16.38	Rugby GAS		Great Britain	31.58	Rio de Janeiro P3A		Brazil
16.5	Drummondville (CFA8)		Canada	31.71	New Brunswick WKJ		United States
16.56	Bandoeng PMC		Java	31.9	Bandoeng PLV		Java
16.56	Buenos Aires LSÝ3		Argentina	32.71	Lawrenceville WNA		United States
16.81	Bandoeng PLF		Java	32.79	Maracay YVQ		Venezuela
16.85	Kootwijk PCV		Holland	32.88	Szekefehervar HAT4		Hungary
16.86	Daventry Empire GSG		Great Britain	33.26	Rugby GCS		Great Britain
16.878	Boundbrook W3XAL (WJZ)		United States	33.59	London VE9BY		United States
16.88	Eindhoven PHI		Holland	34.68	Rio de Janeiro PSK (PRA3)		Canada
16.89	Königswusterhausen DJE		Germany	36.65	Quito HCJB		Brazil
19.47	Riobamba PRADO		Ecuador	37.04	Rabat (CNR)		Ecuador
19.56	Schenectady W2XAD (WGY)		United States	37.33	Suva VPD		Morocco
19.61	La Paz CP4		Bolivia	37.41	Tokio JIAA		Fiji Isles
19.63	New York W2XE (WABC)		United States	38.07	Radio Nations HBP		Japan
19.67	Coytesville N.J. WIXAL (WEED)		United States	38.47	Kootwijk PDM		Switzerland
19.67	Tashkent (Rim)		U.S.S.R.	38.65	Tashkent RIM		Holland
19.68	Radio Colonial FYA		France	39.34	Moscow RKI		U.S.S.R.
19.72	Saxonburg W8XK (KDKA)		United States	39.76	Riobamba PRADO		U.S.S.R.
19.8	Zeesen DJB		Germany	39.82	Radio Nations HBQ		Ecuador
19.815	Daventry (Empire) GSF		Great Britain	40.3	Bogota HJ3ABB		Switzerland
19.84	Rome (Vatican) HVJ		Italy	40.5	Rocky Point WEN		Colombia
19.88	Moscow (RJK)		U.S.S.R.	40.54	Bogota HKE		U.S.A.
19.93	W8XK, Saxonburg (KDKA)		United States	41.55	Las Palmas EA8AB		Colombia
20.27	Rocky Point WQV		United States	41.6	Singapore VSIAB		Canary Isles
20.31	Rocky Point N.Y. (WEB)		United States	41.67	Grenada YN6RD		Sts. Sett'l'mts.
21.43	Cairo SUV		Egypt	41.84	Manizales HJ4ABB		Nicaragua
21.53	Rocky Point WIK		United States	41.9	Madrid EA4AQ		Colombia
21.58	Rocky Point WQP		United States	43	Budapest HAT2		Spain
21.605	Rocky Point WQT		United States	43.86	Rocky Point WQO		Hungary
21.83	Drummondville CJA8		Canada	44.61	Maracay YVQ		United States
22.26	Rocky Point WAJ		United States	44.96	Constantine FM8KR		Venezuela
22.48	Santa Rita YVQ		Venezuela	45	Guatemala City		Tunis
22.684	Zeesen (DHB)		Germany	45	Guayaquil HC2RL		S. America
23.39	Radio Maroc (Rabat) CNR		Morocco	45.02	Moscow RW72		Ecuador
24.41	Rugby GBU		Great Britain	45.38	Barranquilla (HJLABB)		U.S.S.R.
24.9	Kootwijk PDV		Holland	46.53	Boundbrook W3XL (WJZ)		Colombia
25	Moscow RNE		U.S.S.R.	46.69	Boston WIXAL		United States
25.25	Radio Colonial, Paris (FYA)		France	46.7	Cali HJ5ABB		United States
25.25	Saxonburg (Pa.) W8XK (KDKA)		United States	47	S. Domingo HIZ		Colombia
25.28	Daventry (Empire) GSÉ		Great Britain	47.5	Domingo HIAA		Dominican R.
25.34	Wayne W2XE (WABC)		United States	47.8	Winnipeg CJRO		Dominican R.
25.4	Rome ZRO		Italy	48.75	Caracas YV3BC		Canada
25.45	Boston WIXAL (WEED)		United States	48.78	Saxonburg (Pa.) W8XK (KDKA)		Venezuela
25.51	Zeesen DJD		Germany	48.86	Moscow (RKK)		United States
25.532	Daventry (Empire) GSD		Great Britain	49	Johannesburg ZTJ		U.S.S.R.
25.63	Radio Coloniale FYA		France	49.02	Wayne W2XE (WABC)		South Africa
26.83	Funchal CT3AQ		Madeira	49.08	Caracas YVBC		United States
27.65	Nauen DFL		Germany	49.1	Halifax VE9HX (CHNS)		Venezuela
27.86	Rugby GBP		Great Britain	49.18	Boundbrook W3XAL (WJZ)		Canada
27.88	Marapicu PSG		Brazil	49.18	Chicago W6XF (WENR)		United States
28.28	Rocky Point (N.J.) WEA		United States	49.22	Bowmanville VE9GW (CRC1)		United States
28.5	Sydney VLK		N.S. Wales	49.26	St. John VE9BJ (CFBL)		Canada
28.98	Buenos Aires LSX		Brazil	49.3	La Paz CP5		N. Brunswick
29.03	Bermuda ZFD		West Indies	49.34	Chicago W9XAA (WCFI)		Bolivia
29.04	Ruyselede (ORK)		Belgium	49.39	Maracaibo V5BMO		United States
29.16	Zeesen (DIQ)		Germany	49.4	Vienna OER2		Venezuela
29.35	Marapicu PSH		Brazil	49.43	Vancouver VE9CS (CKFC)		Austria
29.39	Leopoldville OPM		Belgian Congo	49.47	Nairobi VQ7LO		Brit. Columbia
29.64	Marapicu PSI		Brazil	49.5	Philadelphia W4XAU (WCAU)		Kenya Colony
29.84	Abu Zabel, Cairo SUV		Egypt	49.5	Cincinnati W8XAL (WLW)		United States
30	Radio Excelsior LRS		Argentina	49.586	Daventry (Empire) GSA		United States
30.1	Rome IRS		Italy	49.6	Bogota HJ3ABI		Great Britain
30.4	Lawrenceville WON		United States	49.67	Boston WIXAL (WEED)		Colombia
30.4	Tokio JIAA		Japan	49.83	Zeesen DJC		United States
30.00	Madrid EAQ		Spain	49.9	Singapore ZHI		Germany
30.77	Lawrenceville WOF		United States	49.92	Havana COC		F.M. States
30.9	Rugby GCA		Great Britain	49.96	Drummondville VE9DN (CFCF)		Cuba
31.3	Daventry (Empire) GSC		Great Britain	50.8	Barcelona EA3AB		Canada
31.23	Mexico City XETE		Mexico	50.8	Moscow RNE		Spain
31.26	Radio Nations HBL		Switzerland	50.26	Rome (Vatican) HVJ		U.S.S.R.
31.28	Philadelphia W3XAU (WCAU)		United States	50.26	Vatican		Italy
31.28	Sydney VK2ME		N.S. Wales	50.42	Domingo HIX		Rome
31.35	Millis W1XAZ (WBZ)		United States	50.6	Medellin HJ4ABE		Dominican R.
31.38	Zeesen DJA		Germany				Colombia
31.40	Lisbon CTIAA		Portugal				

(Continued on page 388)



The batteries with
the wrapped cells

Every battery
tested & retested
to ensure for you

- ① PURITY OF TONE
- ② CONSISTENT PERFORMANCE
- ③ LONGER LIFE

G.E.C. HT.

PRICES :
60v: 5/6, 99v: 9/-, 108v: 10/-, 120v: 11/-,
124½v: 11/6, 139v: 12/9, 150v: 14/-. Also
Triple Capacity—60v: 8/6, 120v: 17/6.

MADE IN ENGLAND
SOLD BY ALL RADIO DEALERS

A TRIAL MEANS YOU'LL ALWAYS USE G.E.C. HT.

Advt. of The General Electric Co. Ltd., Magnet House, Kingsway, London, W.C.2.

WORLD'S BROADCAST WAVELENGTHS Continued from page 386

Wave-length	Name of Station	Dial Readings	Country	Wave-length	Name of Station	Dial Readings	Country
56.9	Königswusterhausen (DTG)		Germany	307.1	West Regional		Great Britain
57.03	Rocky Point WQN		United States	307.9	Grenoble PTT		France
58.03	Bandoeng PMY		Java	312.8	Poste Parisien, Paris		France
58.31	Prague		Czechoslovakia	315.8	Breslau		Germany
60.3	Rugby GBC		Great Britain	318.8	Goteborg		Sweden
62.5	Long Island (N.J.) W2X		United States		Algiers		Nor h Africa
62.55	London		Oriario	321.9	Brussels (2)		Belgium
65.93	Rocky Point WAD		United States	325.4	Brno		Czechoslovakia
68.18	Moscow (RFCK)		U.S.S.R.	328.6	Radio Toulouse		France
69.44	Rugby GDB		Great Britain	331.9	Hamburg		Germany
70.2	Khabarovsk RV15		U.S.S.R.	335.2	Limoges PTT		France
73	Quito (HCJB)		Ecuador	335.2	Helsinki		Finland
76	Maracay (YV11AM)		Venezuela	338.6	Graz		Austria
80	Lisbon CTICT		Portugal	342.1	London Regional		Great Britain
84.5	Berlin D4AGE		Germany	345.6	Poznan		Poland
84.67	Mozambique CR7AA		East Africa	349.2	Strasbourg		France
85.9	Boston WIXAL		United States	352.9	Bergen		Norway
203.5	Plymouth		Great Britain		Valencia		Spain
204.8	Bournemouth		Great Britain	356.7	Berlin		Germany
204.8	Pecs		Hungary	360.6	Moscow (4)		U.S.S.R.
206	Fecamp		France	362.8	Radio LL Paris		France
207.3	Miskolcz		Hungary	364.5	Bucharest		Roumania
209.9	Beziers		France	368.6	Milan		Italy
211.3	Newcastle		Great Britain	373.1	Scottish Regional		Great Britain
214	Tampere		Finland		Salonika		Greece
215.4	Sofia		Bulgaria		Lyov		Poland
215.4	Radio Lyon		France	377.4	Barcelona (EAJ1)		Spain
216.8	Warsaw No. 2		Poland	382.2	Leipzig		Germany
218.2	Basle, Berne		Switzerland	386.6	Toulouse PTT		France
219.6	L.		Poland	391.1	Midland Regional		Great Britain
221.1	Turin (2)		Italy	395.8	Katowice		Poland
222.5	Milan (2)		Italy	400.5	Marseilles PTT		France
222.6	Dublin		Irish F. State	405.4	Munich		Germany
222.6	Bordeaux S.O.		France		Seville		Spain
224	Königsberg		Germany	410.4	Tallinn		Estonia
224	Montpellier		France		Madrid (España)		Spain
225.6	Lodz		Poland	415.5	Kiev		U.S.S.R.
225.6	Hanover		Germany	420.8	Rome		Italy
225.6	Bremen		Germany	426.1	Stockholm		Sweden
225.6	Flensburg		Germany	431.7	Paris PTT		France
230.2	Stettin		Germany	437.3	Belgrade		Yugoslavia
230.2	Magdeburg		Germany	443.1	Sottens		Switzerland
230.2	Danzig		Germany	449.1	North Regional		Great Britain
231.8	Linz		Austria	455.9	Langenberg		Germany
231.8	Salzburg		Austria	463	Lyons PTT		France
231.8	Dornbirn		Austria	470.2	Prague (1)		Czechoslovakia
233.5	Aberdeen		Great Britain	476.9	Trondheim		Norway
235.1	Dresden		Germany	483.9	Brussels (1)		Belgium
236.8	Stavanger		Norway	491.8	Florence		Italy
238.5	Nurnberg		Germany	499.2	Sundsvall		Sweden
240.2	San Sebastian		Spain	506.8	Rabat		Morocco
242	Rome (3)		Italy	514.6	Vienna		Austria
243.7	Juan-les-Pins		France		Agen		France
244.5	Cork		Irish F. State	522.6	Riga		Latvia
245.7	Gleiwitz		Germany	531	Mühlacker		Germany
247.5	Trieste		Italy	539.6	Athlone		Irish F. State
249.2	Lille PTT		France	549.5	Beromünster		Switzerland
251	Prague Stranice (2)		Czechoslovakia	559.7	Budapest		Hungary
251	Frankfurt-am-Main		Germany		Wilno		Poland
251	Trier		Germany	569.3	Bolzano		Italy
251	Freiburg im-Breisgau		Germany		Viipuri		Finland
253.2	Cassel		Germany	578	Ijubljana		Yugoslavia
255.1	Kaiserlautern		Germany	696	Innsbruck		Austria
257.1	Kharkov (2)		U.S.S.R.	748	Hamar		Norway
261.1	Copenhagen		Denmark	765	Oulu		Finland
261.1	Monte Ceneri		Switzerland	765	Moscow		U.S.S.R.
263.2	London National		Great Britain	824	Geneva		Switzerland
265.3	Turin (1)		Italy	845	Boden		Sweden
267.4	Horby		Sweden	1,107	Ostersund		Sweden
267.4	Belfast		N. Ireland	1,144.2	Smolensk		U.S.S.R.
269.5	Nyiregyhaza		Hungary	1,154	Fumark		Norway
270	Kosice		Czechoslovakia	1,221	Moscow (2)		U.S.S.R.
270	Radio Vitus (Paris)		France	1,261	M. dona		Norway
271.7	Moravska-Ostrava		Czechoslovakia	1,304	Oslo		La via
274	Naples		Italy	1,354	Leningrad		Norway
274	Madrid EAJ7		Spain	1,389	Kalundborg		U.S.S.R.
276.2	Falun		Sweden	1,442	Luxembourg		Denmark
278.6	Zagreb		Yugoslavia	1,500	Warsaw		Luxembourg
280.9	Bordeaux PTT		France	1,571	Motala		Poland
283.3	Tiraspol		U.S.S.R.	1,612.3	Eiffel Tower		Sweden
285.7	Bari		Italy	1,648	Minsk		France
288.5	Scottish National		Great Britain	1,724	Droitwich National		U.S.S.R.
291	Leningrad (2)		U.S.S.R.	1,807	Ankara		Great Britain
293.5	Rennes PTT		France	1,875	Deutschlandsender		Turkey
296.2	Königsberg		Germany	1,935	Istanbul		Germany
298.8	Parede		Portugal		Radio Paris		Turkey
301.5	Barcelona (EAJ15)		Spain		Moscow No. 1		France
301.5	North National		Great Britain		Lahti		U.S.S.R.
304.3	Bratislava		Czechoslovakia		Kootwijk		Finland
304.3	Hilvesum		Holland		Huizen		Holland
304.3	Genoa		Italy		Brasov		Holland
304.3	Cracow		Poland		Kaunas		Holland
							Roumania
							Lithuania

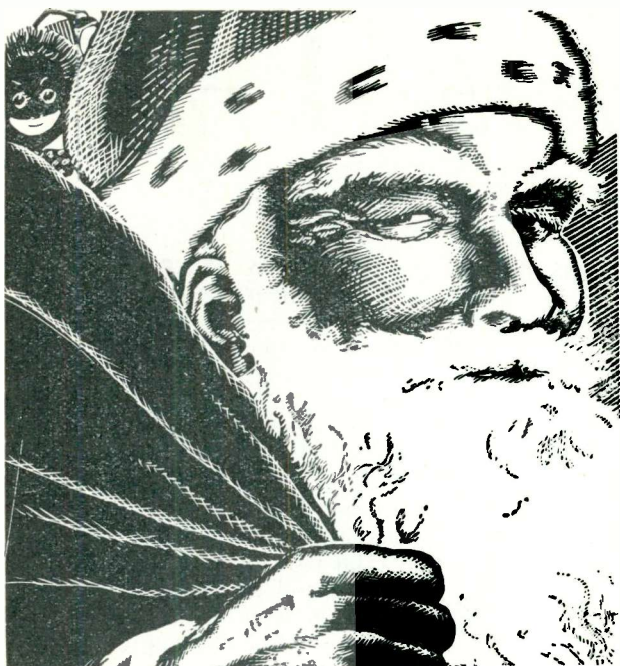

Take a tip from Father Christmas

He knows a thing or two about radio—for instance, that you can't get good reception without good batteries. That's why he's brought a full stock of Anodex Dry Batteries and Smith's Accumulators with him this season. Look for them in your dealer's window.

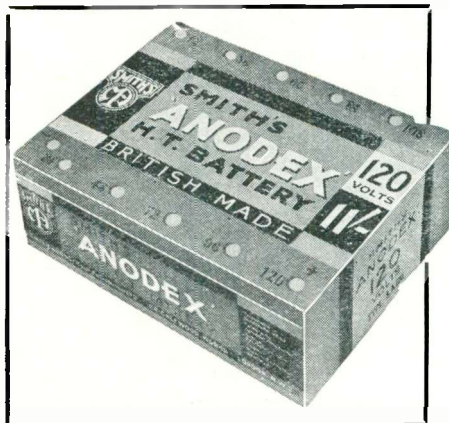

The new 'Anodex' are the ideal Dry Batteries for radio use, having an exceptionally long "working life" and recuperative powers well beyond the normal. Write for free illustrated folders.

SMITH'S WIRELESS BATTERIES

S. SMITH & SONS (Motor Accessories), LTD.
CRICKLEWOOD LONDON, N.W.2



Advertisers like to know you "saw it in the 'Wireless Magazine'"

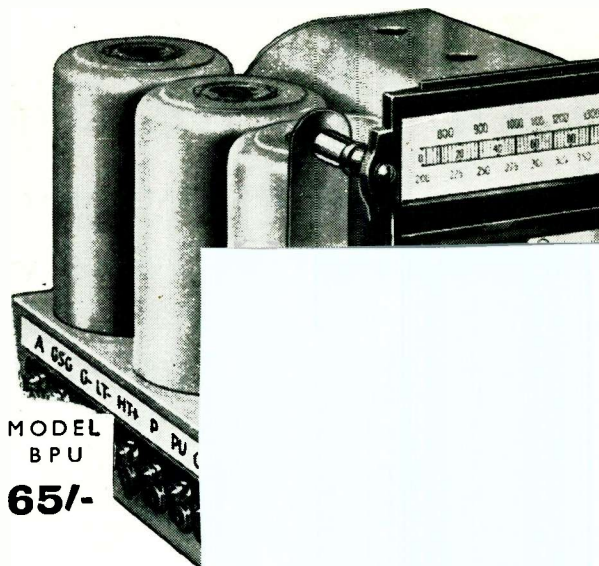

J.B. UNIVERSAL LINACORE TUNER

Constructing and working a set is simplicity itself with a J.B. Linacore Tuner. It gives the 3-valve set performance equal to a superhet. It is not by any means the least important part of the "De-Luxe D.C. Three."

THE DESIGNER'S UNBIASSED CHOICE

for the
DE-LUXE D.C. THREE



JACKSON BROS., (London) Ltd., 72 St. Thomas Street,
London, S.E.1. Tel: Hop. 1837.

In Tune with the Trade

FETTER LANE'S Review of the Latest Catalogues

WET BATTERIES

DETAILED of high- and low-tension batteries, other than the usual dry type, have arrived from the Wet Battery Co. The folder and leaflet describes in detail the use of Leclanché-type cells for this purpose.

These provide a cheap and reliable form of supply, the makers claiming that they work out at half the cost of the ordinary high-tension batteries. Trays can be supplied to house the cells, thus allowing the units to be neat and self-contained.

Apart from an inspection every two or three months, the cells will continue to give a very smooth and silent supply for a year or more before renewal is necessary. Renewal spares are really quite cheap.

Evaporation is prevented by the use of a film of oil on the electrolyte, and this also overcomes the tendency for the liquid to creep over the edge of the container. **427**

COSSOR WIRELESS BOOK

AN interesting little booklet this new Cossor one that should find a home in every enthusiast's file. While several pages, as one would expect, are devoted to detailed descriptions of numerous Cossor valves, many more contain useful general radio information.

If one wishes to check up or determine the value of a decoupling, or voltage-dropping, resistance, it is only a matter of turning to page 9 where all these details are neatly tabulated.

The section devoted to radio definitions will help to remove any doubt regarding the various technical terms. The principles of the super-het, class-B amplification, and automatic volume control are dealt with in a most lucid manner.

Many useful circuits, together with other interesting matter, complete this handy little book. **428**

MAGNUM PRODUCTS

BURNE-JONES & CO., LTD., manufacturers of Magnum components, have just released a folder illustrating several of their products which should have a wide appeal to constructors. Volume controls, high-frequency chokes, coils (canned and otherwise) and solid dielectric variable condensers are described.

For those requiring metal screening boxes, chassis assemblies, or a new type of multi-contact switch, this folder will supply all the necessary details. **429**

UTILITY TELEVISION

TELEVISION enthusiasts will be interested in a leaflet we have just received from Wilkins and Wright, Ltd., describing and illustrating their new mirror drum.

This has been designed to fill the demand for a mirror drum which could be easily and accurately adjusted and, when adjusted, to maintain its adjustment indefinitely.

This new mirror drum is light in weight, and therefore needs only a small motor to drive it. Television enthusiasts should jump at this for the price is quite low. **430**

FULLER INERT CELLS

IT has always been a problem for listeners in the tropics, or other parts of the globe where dry batteries are not satisfactory and accumulator charging facilities are not available, to obtain a satisfactory source of high- and low-tension supply. Readers who suffer these difficulties will welcome the introduction by the Fuller people of their latest types of inert cells.

These cells are a modified form of dry cell and possess the great advantage of not deteriorating, no matter how long they are stored. They are actually inert until water is added to make them active. Each cell gives an initial voltage of 1.5, and is capable of supplying anode currents up to 15 or 20 milliamperes in the case of size No. 1, and from 20 to 30 milliamperes when the larger No. 2 size is used.

We understand that this type of battery will give a useful life of over twelve months: this being based on a daily service of five to six hours. **431**

MANUFACTURERS & HOME CONSTRUCTORS!

You may possess a good set, but why not make it **PERFECT, UP-TO-DATE** and really **UNIVERSAL** with the latest type



or build up one of our Universal All-Wave **KITS** of which we offer you a comprehensive range.

There are also Radiograms and quality Amplifier Kits. Ask for Literature "F," giving details of Valves and Kits and also particulars of our scheme for converting your present set to a modern All-Mains, All-Wave Receiver.

E. J. FORBAT, 28-29 Southampton St., Strand, W.C.2
Telephone: TEMple Bar 8608.

ALL RECORDS BEATEN AGAIN BY THE NEW RADIO STAR HYVOLTSTAR

1. They were the first and only really Universal sets on the market.
2. They are the cheapest Universal All-wave Sets.
3. They are the only sets which will work on 100 volts D.C. mains plant direct, as well as on any other mains up to 260 volts without the use of Generators, Transformers, Barretters, cut-down Resistances, etc.
4. They are the cheapest Universal All-wave Radiograms.
5. They are, by far, the cheapest sets in consumption, too.

(Read "Wireless Magazine" "Set Buyers Guide," November issue) Write for leaflet "F," giving particulars of complete range of Universal Receivers, Radiograms, Amplifiers and Short-wave Adaptors.

UNIVERSAL HIGH VOLTAGE RADIO, LTD.,
28-29 Southampton Street, Strand, W.C.2 'Phone: TEMple Bar 4985

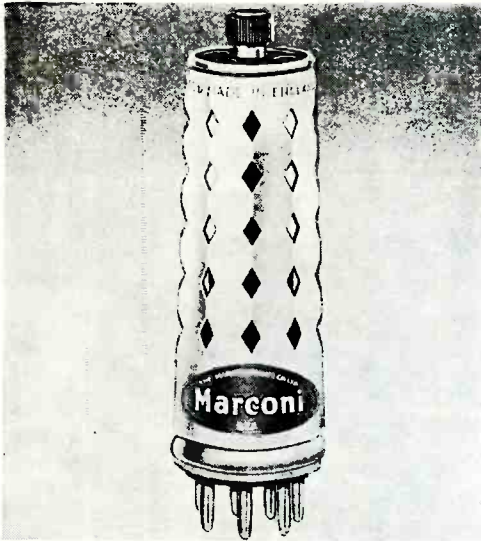

UNIVERSAL VALVES

FOR A.C./D.C. AND CAR RADIO

Marconi Universal Valves have a 0.3 Amp. 4-Watt heater of humless construction, combining a high slope with exceptional freedom from the modulation hum which is so often troublesome with series-operated filaments. A general performance comparable with that of the best A.C. types is thus obtainable, with maximum outputs up to 3.2 watts.

THE MARCONI UNIVERSAL RANGE

X30...Heptode.....	20/-	N30...Pentode.....	18/6
W30...Var.-Mu. H.F. Pen.	17/6	U30...Rectifier.....	15/-
H30...Triode.....	13/6	DH30 D.-D. Triode.....	15/6
		301...Barretter.....	12/6

● A card to The Marconiphone Co. Ltd., Radio House, Tottenham Court Road, W.1, will bring you a copy of the comprehensive new Catalogue of Marconi Valves.

MARCONI 16 VOLT D.C. VALVES

There is a complete range of Marconi D.C. Types, each with a 16 volts .25 amp. heater. Details will be sent on request.

MARCONI



VALVES

THE CHOICE OF THE EXPERTS

See at once what's wrong!



A sudden silence in your set . . . or a baffling, aggravating noise! What is it? With the Avometer you can find out at once.

This ingenious scientific instrument is actually TEN testing instruments in one, giving ten different ranges of readings in milliamps, volts and ohms. It enables you to make every conceivable test with the ease and precision of the electrical engineer, but without his specialised knowledge and skill.

Supplied in handsome case with pair of leads, interchangeable crocodile clips and testing prods, and booklet of instructions showing diagrammatically how to make every test.



40%

Deferred Terms if desired.

THE D.C. AVOMINOR

TELLS THE WHOLE TRUTH

The testing of valves and valve circuits is no longer a tiresome business with your fingers getting in the way. The Avometer enables you to make every test with ease, under actual working conditions, but externally on the bench instead of grovelling about inside the set, and without having to sever any connections. You simply plug the valve under test into the Avometer base and insert the Avometer plug in the valve-holder in your set. Supplied with comprehensive instruction book. Adaptable for 4-pin, 5-pin, or 7-pin valves.

The AVODAPTER . . .

Fully descriptive Folders Post free from:—

AUTOMATIC COIL WINDER & ELECTRICAL EQUIPMENT CO., LTD.
Winder House, Douglas Street, London, S.W.1. Victoria 3404-7.



Complete 25/-
Plus only with 6-way lead . . . 7/6

- CURRENT**
0-6 m/amps.
0-30 "
0-120 "
- VOLTAGE**
0-6 volts.
0-120 volts.
0-300 volts.
- RESISTANCE**
0-10,000 ohms.
0-60,000 "
0-1,200,000 "
0-3 megohms.

"RADIO SERVICING SIMPLIFIED."

Everyone should have this invaluable book. It explains every phase of fault-tracing step by step in non-technical language. The comprehensive information and numerous diagrams render testing and servicing a matter of straightforward procedure.

2/6

or post free, 2/9.

Mention of the "Wireless Magazine" will ensure prompt attention

THE SUPREME INSTRUMENT FOR HOME ENTERTAINMENT

The supreme instrument for home entertainment—the “His Master’s Voice” all-electric Radiogram—is brought within reach of every music lover in the country by the two splendid instruments described below. No instruments are more worthy of the great name they bear than these. Their success has been overwhelming. To realise all they offer in performance, appearance and value, you must see and hear them. Ask your dealer for a demonstration to-night. Then listen to the tone—the faultless reproduction that is characteristic of “His Master’s Voice.”

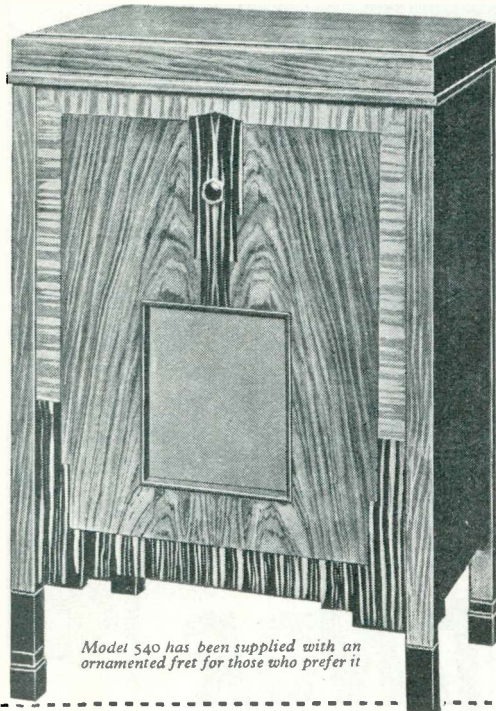

Model 540 has been supplied with an ornamented fret for those who prefer it

“HIS MASTER’S VOICE” FLUID-LIGHT AUTORADIOGRAM

MODEL 570 A.C. Raises the whole level of moderate-priced radiogram design. Combines a magnificent superhet “His Master’s Voice” radio receiver and an automatic record-changing “His Master’s Voice” gramophone, in a richly figured walnut cabinet that is a masterpiece of furniture design. Features incorporated for the first time in a radiogram at this price: “Fluid-Light” Tuning; delayed automatic volume control; static suppressor; automatic record change; inclined moving coil loudspeaker.

33 GNS
or by hire purchase

FIVE-VALVE SUPERHET RADIOGRAM

MODEL FIVE-FORTY. Radio and records rendered true to life! What else can you buy at the rate of 5/- a week that will give you so much pleasure as this delightful “His Master’s Voice” all-electric Superhet Radiogram? Marvellous selectivity and sensitivity. Beautiful cabinet work. A.C. Model 20 gns. D.C. Model 21 gns. Model 540A with QAVC (for districts where fading is particularly prevalent) 22 gns. A.C. only. Any model small deposit and £1 a month. Model FIVE-FOUR-TWO, same as the 20 gn. 540 but with Automatic Record Change, 27 gns. or small deposit and 27/6 a month. A.C. only.

YOURS FOR 5/- A WEEK

See pages 462 and 463 for details of “His Master’s Voice” November Records and hear them on one of these Radiograms.

To The Gramophone Co. Ltd., 108, Clerkenwell Road, London, E.C.1.
Please send me complete illustrated catalogue of the full range of “His Master’s Voice” models.

NAME.....

ADDRESS.....

Please write clearly in ink in BLOCK LETTERS and post in an unsealed envelope using 1d. stamp

“HIS MASTER’S VOICE” RADIO

(Prices do not apply in I.F.S.)

Advertisers like to know you “saw it in the ‘Wireless Magazine’”

A Radio Fan's Causerie



Radio

Medley

By BM/PRESS

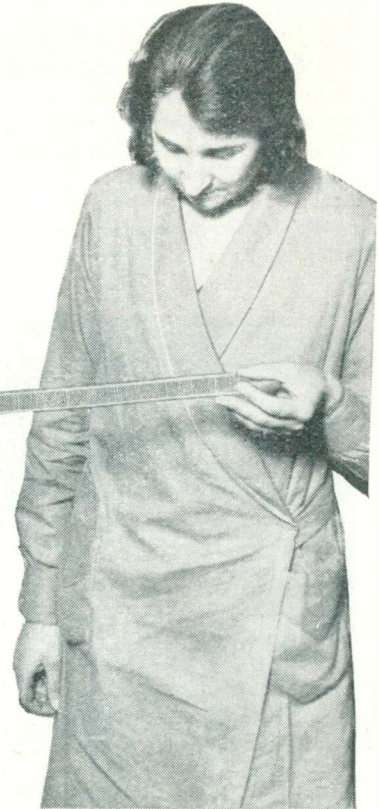
**House in Order!**

A LOT of discussion is going on in radio trade circles about the exhibitions: should there be more than one, and, if so, when should they be held? Most important, I know, but there is another matter to which the trade should give its immediate attention. If it does not put its house in order in this respect the whole industry will be losing public goodwill.

If you are a keen constructor you will know to what I am referring—bad deliveries. It is evident that many of the “casuals” have dropped out of construction and that fewer firms are catering for this market; as a result you would naturally suppose that those manufacturers who are left in the component game would be making the greatest possible efforts to get all the business that is going.

Delivery Difficulties

Yet there does not seem to be the slightest doubt that this season it is more difficult to get delivery of components than it has ever been in the whole history of radio.

I know that the staffs of both “Wireless Magazine” and *Amateur Wireless* have been tearing their hair in despair over this problem. If

there is any doubt about supplies of a particular component being available when a design employing it is about to be published the makers are always consulted; their reply is invariably that stocks are ready and that any reasonable demand can be met.

Disappointment and Annoyance

Yet what is happening in practice? It takes anything from a week to a couple of months to get the parts you need to complete a new receiver. You may think that I am exaggerating the position, but I do not think that I am.

I personally know of a man who waited over seven weeks to get a special cabinet for a set, and have just seen a letter from another constructor who wanted to get hold of a particular type of valve; after waiting for three weeks he got a reply from the manufacturers saying that the type he needed would not be available for at least another seven weeks!

The result of these delays is that constructors are getting fed up with the whole business and many of them are deciding to buy sets rather than build their own.

As you know, I am a firm believer in home construction, but I view with alarm the apathy displayed even by some of the foremost firms

NOT A NEW INDOOR AERIAL
—but a length of screen mesh that is cut into short pieces for use in screen-grid valves. Modern mass-production methods need all the aids that science can give (Mullard photo)

in the component field. It is time that these manufacturers really got down to business and decided two points of policy.

In the first place, no new components should be announced until production is in full swing and adequate supplies are available; secondly, as soon as it is known that stocks are running low the technical papers should be warned not to specify those particular parts for the time being.

A counsel of perfection, I am afraid. But let us cry out loud and make our complaints known to the four winds!

♦ ♦ ♦

“All Wave” or Obsolete

That is the title of a most interesting article that I have just been reading in *The American Exporter*, a trade paper of which the purpose is obvious. At the 1934-5 radio show held in New York City (where, incidentally, it is pointed out that television was conspicuous by its absence) all-wave sets were the order

of the day. If a set is not "all wave" it is obsolete.

As, in matters of this kind, we unfortunately seem always to be behind our American cousins, the American listener again gets better value for his money than we do over here. You have to be very keen to build or buy a separate short-wave set, but if you could get an all-wave set for about the same price as the

hour before the announcement of CT1AA, Lisbon, came over. The relay was of stunts of a French military squadron visiting Portugal.

That may not sound very thrilling when described in cold print, but I can assure you it was almost as exciting as a relay of the Schneider Trophy race! With an all-wave set thousands of listeners would get a new thrill by listening to such relays.

Most of the fun on the short waves is that you never know just what you are going to hear.

Better Aerials Essential

Another thing that caught my eye in this *American Exporter* article was the statement that "the modern radio is so efficient that it is far in advance of the old antenna, stretched anywhere on a house top." What that means is that with the latest sets anti-interference aerials are needed if the best reception is to be obtained.

What applies in the United States also applies over here in this respect.

We are so used to good reception that any old wire is good enough for us; there is no need for me to remind you how unsightly the usual aerial is. If we were really civilised we should not tolerate the drooping lash-ups that disgrace so many gardens all over the country.

It would be a step in the right direction if every listener determined this winter to put up a really neat and

satisfactory aerial. It need not be large nowadays, but the mast might be vertical instead of at an unsightly angle; and the aerial wire and guy lines might be kept reasonably taut.

And those who are troubled with external interference should certainly make use of one of the several screened down-lead systems now available at reasonable prices.

Self-contained Frame Aerials

I still consider that the best aerial is the self-contained frame; not because it is the most efficient, but because it is the most convenient and the least unsightly. What I should like to see is some enterprising cabinet maker turn out a radio-gramophone cabinet with a decent-sized frame aerial built in and arranged to be turned on its pivot by a small knob mounted on the motor-board. I am certain that there would be a market for such a cabinet.

Four years ago the Super 60 did everything any reasonable listener wanted with a small frame aerial, so how much easier it should be to get satisfactory results now with improved valves and components.

With the aerial designed to swing inside the cabinet as I suggest there would be no need to move the cabinet itself, which has the disadvantage that the loud-speaker is not always pointing in the best direction.

Limited Reception

Last month I made some remarks about the falling-off in licence figures in certain areas, and also referred to the fact that the Post Office will not

help you over interference problems provided you can receive British stations all right. Now I have a most interesting letter from M. A. B., of Melton Mowbray, from which I propose to quote some relevant points.

"You ask why licence holders have fallen off in certain districts and then answer the query yourself. Did you notice this? You

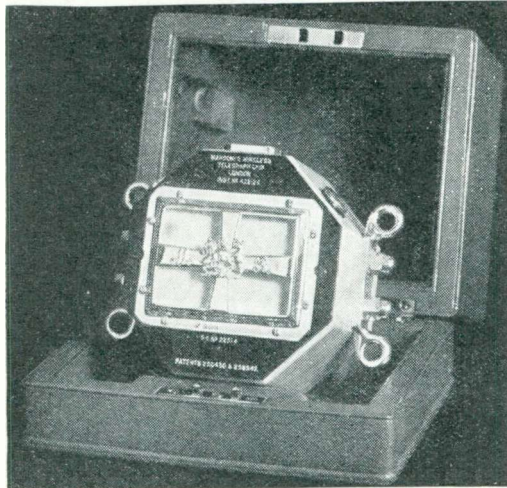

Marconiphone photo

HER MAJESTY'S MICROPHONE
The microphone used for public address by Her Majesty the Queen. It was first used at the unveiling of the Seaman's Memorial at Tower Hill in 1928 and was used again recently for the launching of the "Queen Mary"

usual medium- and long-wave model then you would undoubtedly make use of the short wavebands quite often.

I have never been bitten by the short-wave bug, but I realise that there are lots of interesting things to be heard below 80 metres.

Only a week ago I was down in Cornwall and dropped in to see an enthusiastic radio man. He had a short-wave set going (it was in the afternoon), and what was evidently a relay of some aero display was coming through at good loud-speaker strength.

Announcements were made in three languages, two foreign ones that none of us could recognise, and very pidgin English. We hung on for three-quarters of an

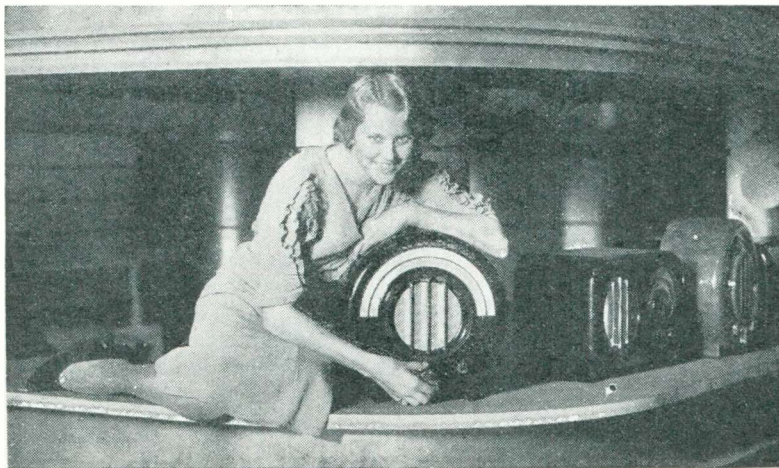

A CHOICE OF SETS FOR CHRISTMAS
This young lady is certainly making herself comfortable over the choice of a new set—and Ekco have types to suit all needs

remark, 'Although you pay 10s. a year to the Post Office . . . they don't care what happens provided you can hear the British stations!' *There is the answer!*

"But the point you make goes deeper than that . . . Knowing something of the towns you mention—knowing rather a lot about a lot of them—I freely assert that the licence charge is *not* the main factor in the decline of licence purchases (*even if it is a factor at all in these places*).

Gramophone Records

"You put your finger on *two causes*. If the average Britisher wants gramophone stuff he will get it from his own gramophone. Many have said to me: 'Oh, wireless? I had one, but I'd sooner have my gramophone.' This, not in one part of Great Britain, but in many.

"I suggest that the net increase in licences is very small to what it ought to be: the increase in the sale of sets very low to what could be obtained by a correct policy on the part of the parties concerned.

"Firstly, the 10s. fee should be made payable on the instalment plan where asked for (a fee of 2s., say, for this accommodation would be a charge of 1s. per month, about 3d. a week). This would bring an immediate increase of thousands of licences . . .

"Secondly, the eternal dance bands (10 to 12 p.m., about) are wicked. Year after year this goes on for cheapness sake, and it has not dawned upon any of the programme compilers of the B.B.C. that however much London may be 'dance-band mad' the provinces certainly are fed up to the teeth with the system.

"I am not speaking of my own personal ideas and desires, but from observations of other people's reactions to the never-ending stream of crooners, etc., in the evenings.

Workers' Needs

"It has yet to strike the programme makers that 10 to 11.30 p.m. is the best (and in millions of cases the only) time to listen-in; and with the long-drawn-out 'news' plus

dance bands night after night, *workers* are fed up.

"They tire of the way the news is dished out and prefer to read the evening papers (where available) and, where not, they prefer to wait for the paper the following morning. The dance bands get them groggy, and they cannot spend hours listening for a favourite snappy song or tune which might or might not 'come on' before mid-



LONDON STORE'S AUDITIONS
During its twenty-seventh birthday celebrations one London store hit on the happy idea of having auditions for customers with broadcasting ambitions. Here is Peggy Evans, age 13, facing the mike for the first time

Pottings photo



RADIOGRAM COCKTAIL BAR
Anne Grey, the British film star, tries out a radio gramophone that has accommodation for cocktail ingredients. What a Christmas present!

Phico photo

night; they prefer to hear it at one of the stores—and buy a record.

Minor Objections

"But, after all, these objections are only minor . . . Perhaps they don't *want* you to hear the foreigners! . . . When you look over the sets

at Olympia and compare them with the best (value for value) American sets I think you will agree that 'they don't care what happens.'

"The British manufacturer is cooking his own goose, and the B.B.C. dance bands provide the fire for the goose to be cooked on. In other words, a successful forward policy should embrace longer-range sets; a change-over in programme outlook; and a 'hire-purchase' system for licences as well as sets."

Thank you, M. A. B., for a long and interesting letter; it should give many people food for thought and, let us hope, for action.

In particular, I think that the Postmaster-General should look into the question of making radio licences payable by instalments. We hear a lot about the difficulty poor people have in raising a whole 7s. 6d. for a dog licence—and the poor are the very people who can get the greatest advantages from broadcasting.

Those who cannot afford to get about much, need radio much more than those who can travel.
London, W.C.1. **BM/PRESS.**

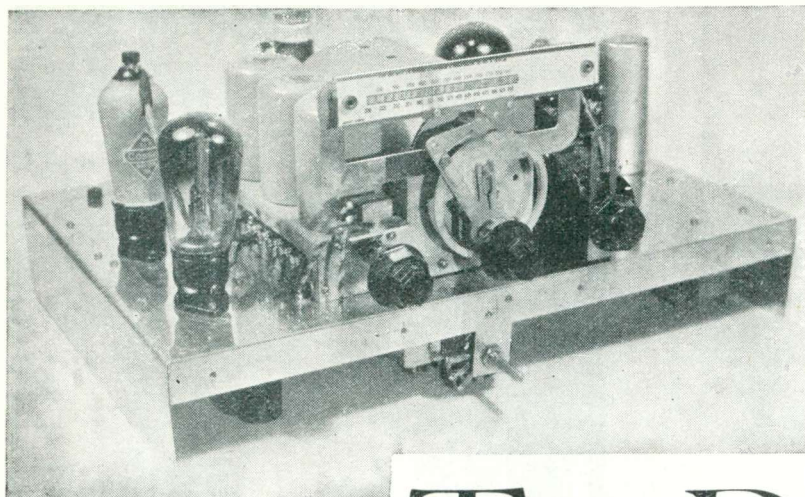

This design is an engineer's idea of what an up-to-date D.C. set should be. We were so impressed by its fine performance that we thought other "Wireless Magazine" readers would like details of it. If you are still on D.C. mains then the set described and illustrated in these pages is just the thing for you

The De-luxe D.C. Three

Described by the "W.M." Technical Staff

IT is a common complaint of those unfortunates who are still on D.C. (direct-current) mains that their interests are not catered for by radio designers. In the past there has, perhaps, been some justification for this grouse, but not so nowadays.

Many of the designs presented to the home-constructor are suitable for both A.C. and D.C. mains without any change whatever being made. That does not meet everybody's wishes, however, and this month we take the opportunity of describing a set intended exclusively for use on D.C. supplies.

Impressive Results

The set illustrated in these pages has been designed by the editor of a well-known engineering paper for his own use: he asked our advice on certain points, and we were so impressed with the results that we

asked him if we could describe it for the benefit of other "Wireless Magazine" readers.

As it is a "three," the valve combination is naturally the ever-popular high-frequency, detector, and pentode arrangement. Actually the high-frequency amplification is carried out by a high-frequency pentode, the detector is a triode, and the power stage is a low-frequency pentode with an anode dissipation of 8 watts.

Such a set will, of course (provided that the tuning system and intervalve couplings are of reasonable efficiency) bring in a large number of stations on the loud-speaker; and if a good type of loud-speaker is used the quality will leave nothing to be desired.

When working from D.C. mains it is usual to run all the valve filaments in series, as this economises the power actually used. In this case

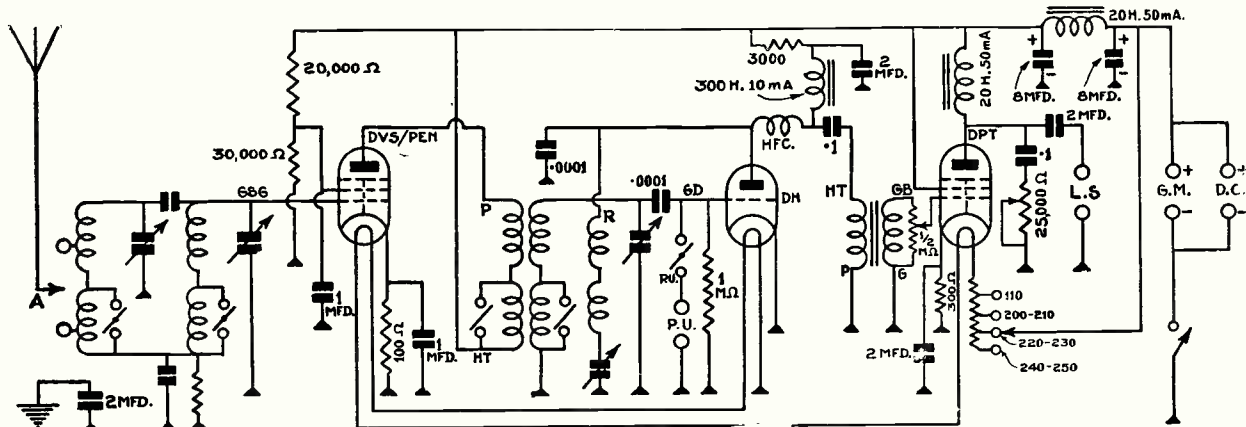

The circuit of the De-luxe D.C. Three is perfectly standard. The valve combination consists of a high-frequency pentode, triode detector and pentode outp. t

all three valves are of the 16-volt .25-ampere type, and their filaments are run in series.

This means that (if the mains voltage is 200) $16 \times 3 = 48$ volts are needed for the set, and that $200 - 48 = 152$ volts will have to be absorbed by an external resistance. Moreover, the total value of resistance in circuit must be such that a current of .25 ampere is passed.

Not Difficult

This problem is not as difficult as it may sound, for it is possible to buy a tapped resistance suitable for various mains voltages. With the type used in this particular set it is possible to tap for mains of the following voltages: (1) 240 to 250, (2) 220 to 230 volts, (3) 200 to 210 volts, and (4) 110 volts.

It is not recommended that the set should be used on 110-volt mains as the anode voltages will be too low to give good results.

Ordinary A.C. Practice

Apart from the fact that the heaters of the valves are run in series from the D.C. mains, the rest of the circuit conforms to ordinary A.C.

gramophone motor if the set is turned into a complete radio gramophone.

The only other mains equipment are two 8-microfarad electrolytic smoothing condensers, a 20-henry choke, and the mains regulator resistance already referred to.

Now let us go to the aerial end of the circuit and note one or two of the special features of the design. In the first place the aerial-tuning circuit is arranged on the band-pass principle, the input being fed into the high-frequency pentode. The coupling between the high-frequency pentode and the detector takes the form of an intervalve transformer.

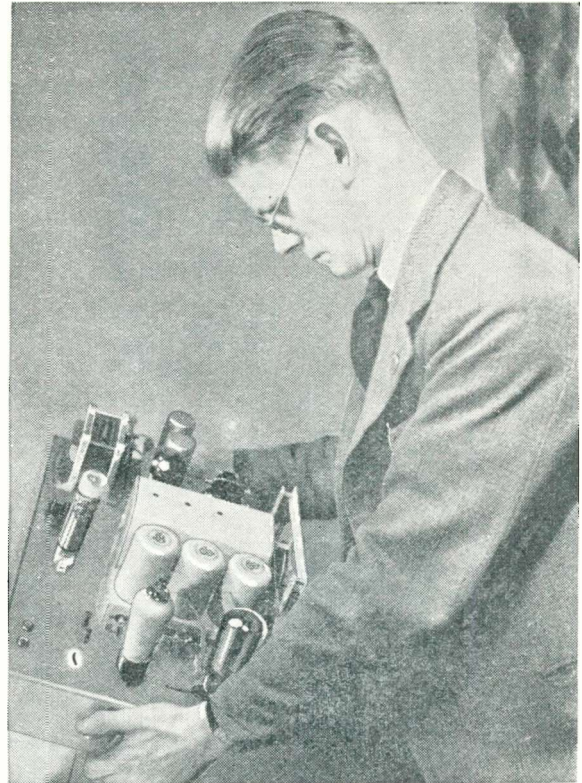

REAL "ENGINEERING"

This fine D.C. set was designed by the editor of a well-known engineering paper and is here described for the benefit of other "Wireless Magazine" readers

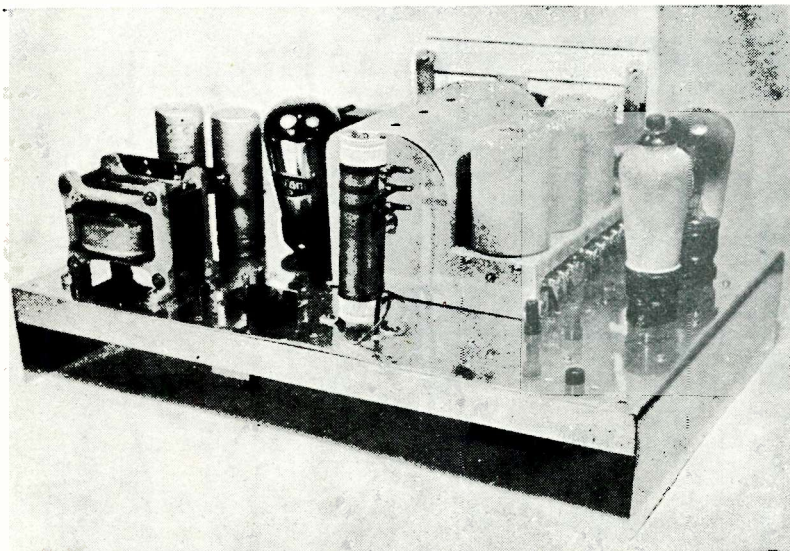

NEAT CHASSIS CONSTRUCTION

This de-luxe D.C. set is built up on the best modern principles, a stout metal chassis being employed. There will be no difficulty about its construction

practice, with the exception, of course, that there is no need to rectify the mains current before it is applied to the anodes.

Starting to look at the circuit backwards, it will be seen that in parallel with the D.C. input are two terminals marked G.M.+ and —; these are for the connection of a

Both the band-pass circuits and the intervalve coupling are tuned by a .0005-microfarad three-gang condenser. In fact, the tuning unit actually used is the Linacore, previously employed so successfully in the Mantovani Three described last month. This unit comprises three tuning coils matched up in produc-

tion with the three-gang condenser. In this way ganging troubles are reduced to a minimum.

The triode detector is arranged on the usual leaky-grid method, terminals for a pick-up being provided. It will be noted that the low-frequency transformer between the detector and the output pentode is coupled by the choke-feed method.

This gives better results than ordinary resistance feed, but is not normally adopted because it is considerably more expensive. As this set has been designed primarily to give good reproduction, however, the use of the choke-feed system is justified.

Volume Control

Volume is controlled by a .5-megohm potentiometer across the secondary of the low-frequency transformer; in this way one control acts both for radio and gramophone reproduction. It will be noted that there is no high-frequency volume control, but the first valve will not easily overload.

The loud-speaker is also choke-fed, it will be noted; again in the interests of quality. In addition, a .1-microfarad condenser and 25,000-ohm resistance are used to control the

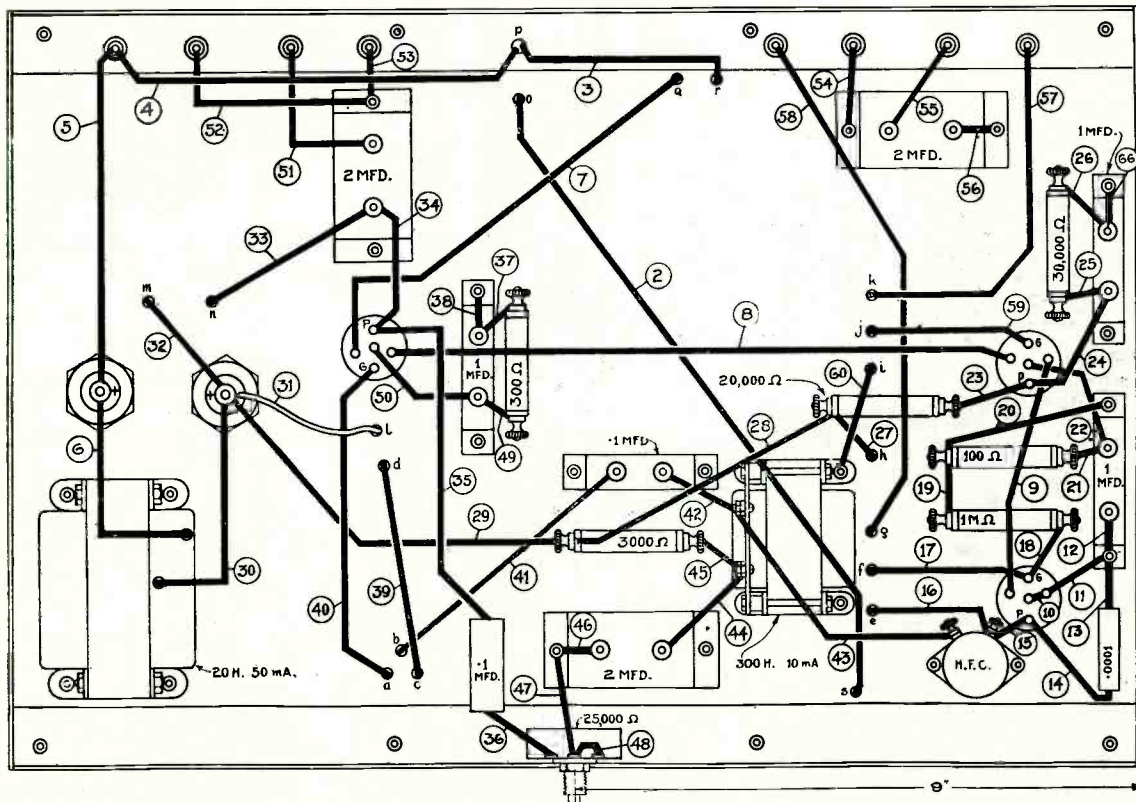
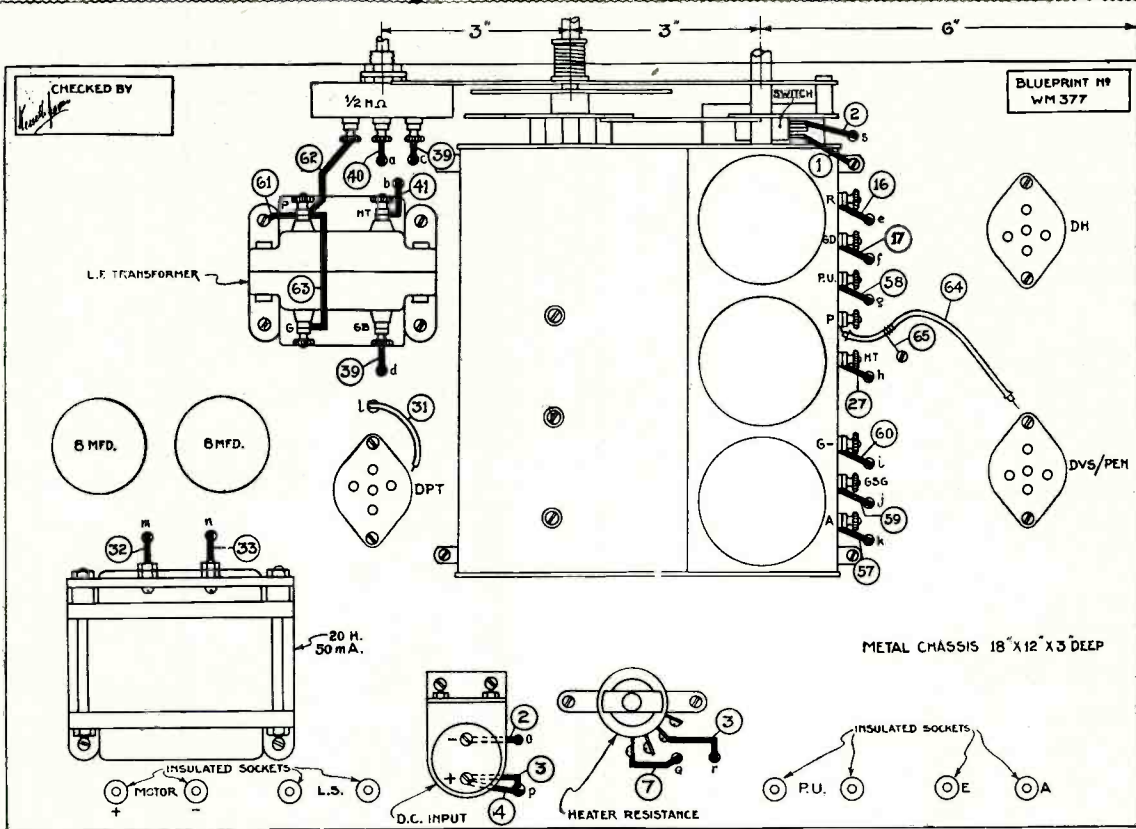

SPECIAL HALF-PRICE BLUEPRINT OFFER

If desired, a full-size blueprint of the De-Luxe D.C. Three can be obtained for half price, that is 6d. post paid, if the coupon, to be found on the last page, is used before December 31. Address your application to the "Wireless Magazine" Blueprint Dept., 58-61 Fetter Lane, London, E.C.4. asking for No. WM377

tone. Without some sort of correction the output from a pentode is inclined to be high-pitched.

Of course, if the loud-speaker to be used is one of the latest type with several tapings for matching this tone control can be dispensed with.

Resistance of Chokes

In all, there are three low-frequency chokes in this set, and it is important that all of them should have the lowest possible resistance, otherwise the anode voltage will be cut down to such a value that reception will be affected. If alternatives to those specified are employed the constructor should make certain that the resistances are not any higher than the resistances of those parts actually used in the original design.

It will be seen from the photographs that the set is constructed on a stout metal chassis; the parts are comparatively few in number and the assembly is not at all complicated.

Full-size Blueprint

In these pages we include a third-scale layout and wiring diagram, but those who desire one can, of course, obtain a full-size photographic blueprint for half price, that is 6d., post paid, if application is made to the "Wireless Magazine" Blueprint Dept., 58-61 Fetter Lane, London, E.C.4, by December 31. When ordering, ask for No. WM377.

The appearance of the top of the chassis is remarkably neat, and the underneath is also fairly "clean." Much of the usual trouble of assembling parts is avoided by the use of a

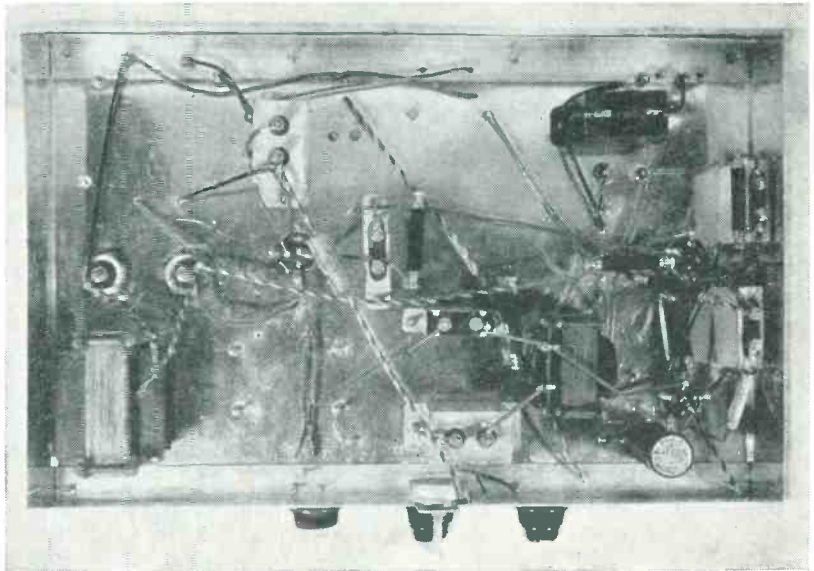
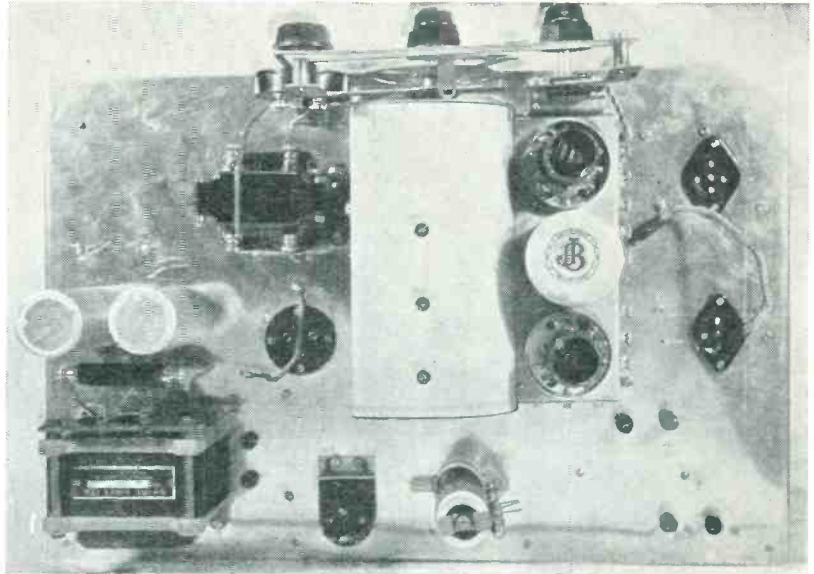

TOP AND BOTTOM PLAN VIEWS

These two plan photographs show the assembly of the parts on the top and undersides of the de-luxe D.C. Three chassis. They should be consulted in conjunction with the third-scale layout guide reproduced opposite

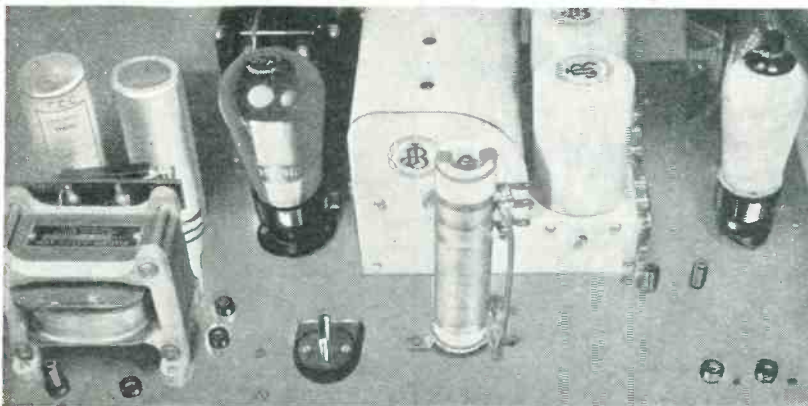

SPECIAL MAINS REGULATOR RESISTANCE

Just in front of the tuning unit is seen the mains regulator, which must be adjusted for the voltage of the supply on which the set is to be used. To the left of it is the mains socket

complete tuning unit. Note that the detector valve is nearest the front of the set on the right (looking from the back) and the high-frequency pentode is immediately behind it. The output pentode is on the left of the tuning unit.

Insulated Sockets

Insulated sockets for the aerial, earth, and pick-up are mounted on the right of the chassis, while two other pairs for the gramophone motor and loud-speaker are mounted on the left. The mains socket is also fixed to the top of the chassis, a little to the left of the tuning unit.

The volume control is mounted

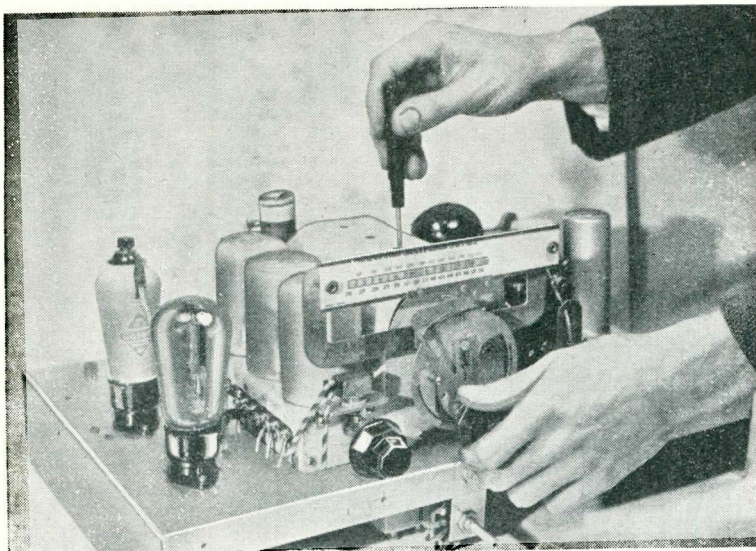

NO GANGING DIFFICULTIES
Owing to the fact that the coils in the tuning unit are matched up with the condenser during the course of manufacture, there is no difficulty about the final trimming up for the best results

on a bracket that is an integral part of the tuning unit.

All the small parts are mounted on the underside of the chassis, where they are readily accessible when it comes to wiring.

Numbered Wires

As is the case with all "Wireless Magazine" blueprints, each connecting wire is numbered separately and the numbers, taken in their proper sequence, indicate the best and most convenient order of making the connections. In addition to the numbering of the wires, all the holes in the chassis through which wires pass from one side to the other are marked with small letters so that they can be easily and quickly identified.

When the set is wired, whether a full-size blueprint or the reduced-scale reproduction in these pages is used, the numbers should be crossed

through with a pencil as the corresponding connection on the set is completed. In this way there is no possibility of making a mistake.

It is not recommended that any other valves than those specified should be used in the De-luxe D.C. Three. The set works particularly well with the combination recommended and any alteration of types may affect the results adversely.

No cabinet has been shown in the photographs reproduced in these pages. It will be apparent that the set can equally well be built up into a table cabinet with or without a built-in loud-speaker, and it also lends itself very well to a complete radio-gramophone assembly. That is a matter for the individual constructor to decide for himself.

It is important, before the set is actually connected to the mains, that the regulator resistance mounted

on the top of the chassis should be adjusted for the correct voltage or the valves will be damaged.

Make certain of the voltage of the house supply, and then tap off on the regulator at the point marked for the proper voltage. The valves used in this set will take 200 volts on the anode and it is obvious that if the set is used on 110-volt mains that the reception will be poor.

Earth-lead Condenser

Note that a 2-microfarad condenser is included in the earth lead. *This is essential* to prevent a short-circuit of the mains, as might happen if the chassis were accidentally earthed direct.

It should be remembered when the first test is made that unless the polarity of the mains is correct, nothing will be heard. It is a good plan for those on D.C. mains to provide themselves with a supply of pole-finding paper or a polarity indicator. In this way much trouble will be saved.

Trimming Up

Before the set is finally placed in its cabinet, it will be necessary to trim up the tuning circuits. Owing to the fact that the coils are matched up to the gang condenser during the course of manufacture, this will not be a difficult matter.

Choose a fairly weak station at the lower end of the medium waveband and adjust all three trimmers in turn (starting from the back) until the best signal is obtained. Then repeat the process towards the top end of the medium waveband. Finally, it may be desirable to trim up again on the long waveband.

Trimming should, of course, be done when the valves normally to be used in the set are in position.

COMPONENTS YOU WILL NEED FOR THE DE-LUXE D.C. THREE

CHASSIS		HOLDERS, VALVE		SUNDRIES	
1—Peto-Scott, 18 in. by 12 in. by 8 in.	£ s. d. 10 6	3—Clix, type chassis mounting 5-pin ...	1 6	Round tinned copper wire for connecting, No. 20 gauge, say ...	9
CONDENSERS, FIXED		PLUGS, TERMINALS, ETC.		Oiler sleeving (Goltone), say ...	1 3
1—T.C.C. .0001-microfarad, type tubular (or T.M.C. Hydra) ...	1 0	8—Clix insulated plugs and sockets, red (4), black (4) ...	2 8	1—Aluminium mounting bracket, 2¼ in., say ...	3
1—T.C.C. 1-microfarad, type tubular (or Dubilier) ...	1 4	RESISTANCES, FIXED		1—Aluminium mounting bracket, 1¼ in., say ...	3
1—T.C.C. 1-microfarad, type 65 (or Dubilier) ...	1 8	1—Graham Farish 100-ohm ½-watt type ...	1 6	6 in. screened sleeving, say ...	3
3—T.C.C. 1-microfarad, type 65 (or Dubilier) ...	6 0	1—Graham Farish 300-ohm, ½-watt type ...	1 6	TRANSFORMER, LOW-FREQUENCY	
3—T.C.C. 2-microfarad, type 65 (or Dubilier) ...	8 0	1—Graham Farish 3,000-ohm, ½-watt type ...	1 6	1—Ferranti, ratio 1/3.5, type AF3 ...	1 5 0
2—T.C.C. 8-microfarad, type dry electrolytic (or Dubilier) ...	10 0	1—Graham Farish 20,000-ohm, ½-watt type ...	1 6	TUNING UNIT	
CHOKES, HIGH-FREQUENCY		1—Graham Farish 30,000-ohm, ½-watt type ...	1 6	1—Jackson Brothers, type BPU ...	3 5 0
1—Varley, type Junior ...	3 6	1—Graham Farish 1-megohm, ½-watt type ...	1 6	ACCESSORIES	
CHOKES, LOW-FREQUENCY		1—Graham Farish 10,000-ohm, 3-watt type ...	2 3	LOUD-SPEAKER	
2—Sound Sales, type 20H ...	1 10 0	RESISTANCES, VARIABLE		1—Amplion, type triple X ...	1 15 0
1—R.I., 300-henry, type DY26 ...	1 1 0	1—Erie 25,000-ohm ...	3 6	VALVES	
		1—Erie 5-megohm ...	3 6	1—Cossor DVS Pen ...	17 6
				1—Marconi DH (or Osram DH) ...	13 6
				1—Marconi DPT (or Osram DPT) ...	18 6

Set Building Stage by Stage



Our photographer recently paid a visit to the huge radio works of E. K. Cole, Ltd., at Scuthend-on-Sea. He brought back this set of pictures showing how Ekco's famous bakelite cabinets are made. (1) Measuring out an appropriate amount of powder to make one cabinet. (2) Taking the "cooked" mould out of the press. (3) Polishing the finished cabinets. (4) Cabinets passing to the assembly benches on an endless belt. (5) Putting an Ekco set chassis in an Ekco bakelite cabinet.



Party Pranks With Your Radio

By L. O. Sparks

WITH the approach of the festive season one starts to think of jolly parties, merry evenings, and all the good things usually associated with this time of the year.

The good old games of grandpa's time were no doubt quite all right in his age, but they are inclined to fall a little flat nowadays. Still, something has to be done.

It caused me a lot of worry; you will appreciate this more when I tell you that I am well over six feet in height, and that my best friend could hardly say that I look like a fairy gambolling about with a slipper tucked up my waistcoat.

You note that I use the past tense—it *caused*—that is because it no longer causes me any loss of sleep or hair, since I decided that my radio should do something to earn its keep.



Quite a lot of fun is caused by the brown-paper loud-speaker trick. The participants can get minute electric shocks as well

Feeling rather generous at the moment, and as it is the season of good will to all men, I will spill the beans and tell you how to help keep the spirit of the party going.

The following spiffing little piece of spoof usually causes a fair amount of fun, and a large portion of mystification. As with most of these pranks, it is advisable to have a reliable confederate in the know, and doing the necessary at the right time.

Assuming that the set and/or loud-speaker is in the room where the séance is to be held, you request all your victims to sit round an oval or round table. They are requested to place their hands, fully extended, around the edge of the table, thus making contact with each other by touching their little fingers.

The master of ceremonies—that's you—does not take the vacant seat until everything is to his liking, then, putting out all lights so that the room is only illuminated by the flickering glow of the fire, he takes his place at the table and completes the circle of hands.

Now this is where the gift of mythology comes in, because it is vital to create the necessary atmosphere of mystery and spooks. You must explain that quiet concentration is essential to make contact, and that no one must break the chain of hands. By a little gentle persuasion the table can be caused to sway and rock about.

The M. of C. then asks if anyone has any questions to ask about their lighter affairs, or who will win the Boat Race, and so on. When the query has been raised and everyone is quiet and serious, he mutters a few weird words of wisdom, and lo and behold a ghostly voice is heard giving the answer, together with as much bunk and patter as the subject allows.

The whole thing can be very effective and amusing, while, if the confederate is up to it, most weird noises can be produced and a real spooky air created.

Now there is nothing very complicated about staging this. All you require is a cheap carbon microphone, or a microphone button will do, which is connected from an adjacent room by fine wires to the pick-up terminals on the set, which, of course, has been switched on beforehand.

The confederate hears the questions by listening outside the door—or, if you have a spare loud-speaker, place this in a suitable position near the table and connect it by means of twin wires to a pair of headphones in the other room: he can hear everything with ease.

With a little co-operation between the two of you, this prank can be well worth the very slight trouble involved.

The talking paper trick can be used to fill up one of those awkward little moments which crop up in the best of regulated parties. You tell the folks that two of them can hear the radio programme by simply catching hold of the loud-speaker wires. This is sure to raise some doubt among those present, so you request two, preferably a lady and gentleman, to step up and try.

After tuning the set you give them each a lead from the loud-speaker output, and tell them not to touch each other. Of course, they do not hear anything, but it is quite possible that they will experience a slight shock if you, after moistening your fingers, touch them both at the same time on a bare spot.

To proceed with the trick it is necessary for you to use a piece of fairly stiff brown paper which you place over one of the lady's ears and then ask the gentleman to hold it in position with one of his ears.

A fair amount of fun is usually caused by the couple assuming the necessary position, but once this has been reached they will find that they can hear the radio programme as clear as a bell. Their remarks will soon tempt others to follow suit, and, if the pairs are wisely chosen, the results can be quite humorous.

It is strange how a microphone exerts a certain fascination over the average person. Everyone like to burble into the little box of tricks, and hear his or her voice issuing forth from the loud-speaker. It is ten to one that they kick off with "Hallo everybody," and then dry up with the most embarrassing quickness.

The beauty of this little idea is that there will be no shortage of victims, as they will all be bursting to show off their capabilities as broadcast artists or announcers. It is advisable to have the mike in one corner of the room, in full view of everybody, and the loud-speaker as far away as possible, consistent with the position of the critics.

Try stump speeches, cod lectures, recitations, humorous or otherwise, although this is really immaterial as the results are usually the same; the critics will *always* laugh at the wrong moment. These are only a few of the many items which lend themselves to this simple but very effective way of breaking the ice and getting everybody in the party mood.

Another variation is possible if the mike is moved into the next room. This calls for three or four performers, a piece of terrible tongue-twisting poetry or limerick, and permission for

the actors to disguise their voices if they so desire.

The object is for listeners to try to recognise the owners of the various voices and, if you have any old bon-bons or cakes—or spare pound notes—then a winner can be selected by vote and suitably rewarded.

The "Old, Old Castle" is a pastime which comes as a very welcome respite after more violent exercises like Postman's Knock or a Spelling Bee. It also comes in very useful if the sideboard is no longer groaning under the proverbial stacks of nuts and wine, cold dogs, or whatever form of refreshment you provide.

It is quite a good idea to put this one over on your guests before the spoof séance as it helps to get everybody in the necessary state of dithers. You require a good imagination and the happy knack of spinning a yarn. Should these proceedings take place late in the evening then it is quite possible that no difficulty will be experienced!

Gather all the folks round the fire—don't trouble to wake up grandpa in the corner as his snores will come in

useful—then put out all the lights. The younger folks simply love this part.

Now, taking a deep breath, you proceed to spin the most ghostly and weird yarn you can concoct, being sure to bring in whole heaps of the following: The old, old castle, the damp and musty vaults, the wind was howling, and whining (a good portion of wind, mind), the rattling of chains and the hollow sound of scampering feet, all well mixed up with a handful of monks and highwaymen.

Continued on page 476



With a mike in one room and a loud-speaker in another, some amusement is got by the party trying to recognise familiar sounds heard via the reproducer



And, of course, radio's chief use at parties is to provide the dance music, Chopstick recommends on page 463 some suitable records

The B.B.C. Plans a New

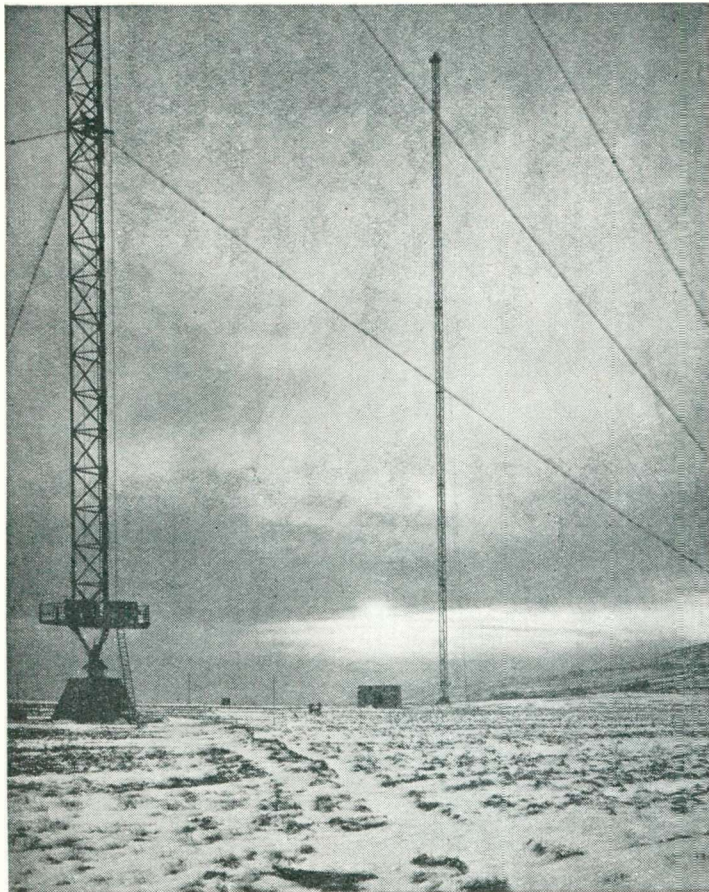

B.B.C. photo

This striking photograph of two of the three masts of the North Regional transmitter, situated on the bleak moors between Huddersfield and Oldham, was taken in mid-winter

IF the Droitwich long-wave station fulfils its designers' hopes, the B.B.C. will virtually abandon its famous regional scheme.

This scheme, I need hardly explain, was planned to give nearly everyone in the British Isles a service of alternative programmes—a National, common to all, and a regional of more localised interest.

Twin centres of radiation seemed to offer the most satisfactory way of providing such a service. Brookmans Park arose, with two 50-kilowatt transmitters, to give London and the South-east a national and regional service of alternatives. Followed, at almost annual intervals, the erection of similar centres for the rest of the country—North at Moorside Edge, Scottish at Westerglen, and West at Washford Cross.

As soon as the scheme was thus completed—Droitwich providing the Midlands with a long-wave National and a regional alternative through an experimental SCE

medium-wave station on the same site—listeners began to realise what a lot of duplication it entailed.

So did foreign broadcasters, particularly those who coveted some of our exclusive wavelengths. They asked why we needed three medium-wave Nationals—London, North and West—when the Droitwich long-wave transmitter could provide—and indeed did provide—the same programme to practically the whole country.

No entirely satisfactory answer could be given by the B.B.C. to the accusation of wavelength wastage. Foreign pressure, and the all-round increase in the power of long-wave stations, must have had something to do with the decision to go ahead with a successor to Droitwich that would enable the medium-wave stations to be shut down without service sacrifice.

Droitwich, with five times the transmitting power of Droitwich, was forthwith planned. Now it is on the air, giving most listeners an enormous signal strength—too enormous for those in the Birmingham area. At the same time, it is not yet clear that Droitwich can do all that Droitwich and the medium-wave Nationals could do.

The trouble centres on night-time reception. Medium-wave nationals that give perfectly reliable daytime signals at, say, 30 miles, tend to fade and distort very badly at night. Many people imagined that a long-wave station would

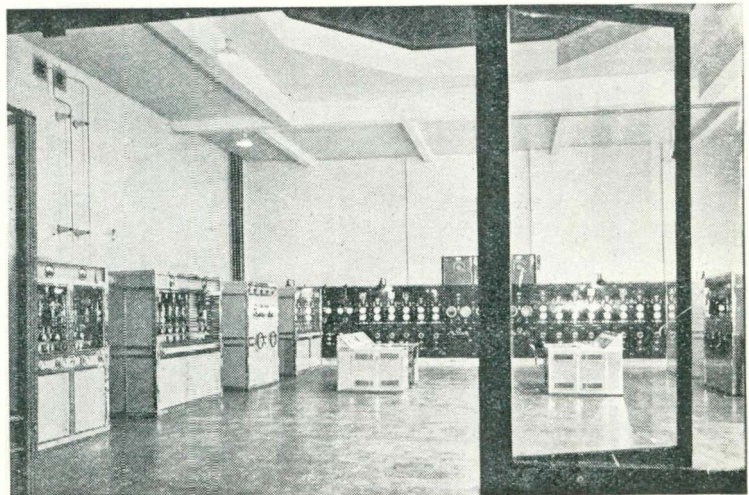

B.B.C. photo

Looking through the big swing doors into the imposing transmitting hall, with its domed roof, at the West Regional station, Watchet. By all accounts, the National transmitter, seen on the left, is doomed

Regional Scheme

be free from this trouble. So it is—at 30 miles. But not at anything from 150 to 250 miles, as thousands of listeners to Droitwich have been discovering.

In the north-eastern area—especially Newcastle—and in many parts of West Devon and Cornwall, not to mention Northern Ireland, I have received harrowing reports of very bad night distortion and fading.

Neither a long wavelength nor high power can stop this sort of seasonal effect. In other words, for all our sensitive sets and giant stations, we still cannot be sure of absolutely reliable reception day and night from distances much over 100 miles—and that assumes a wavelength over 1,000 metres and a power over 100 kilowatts.

As soon as we step up to the long waves other difficulties inherent in the waveband arise. Atmospheric, for instance, are always worse on the long waves than on the medium. In this fortunate country this applies more particularly in the summer months, of course.

There are other forms of crackles not produced by Nature. All kinds of electrical apparatus conspire to

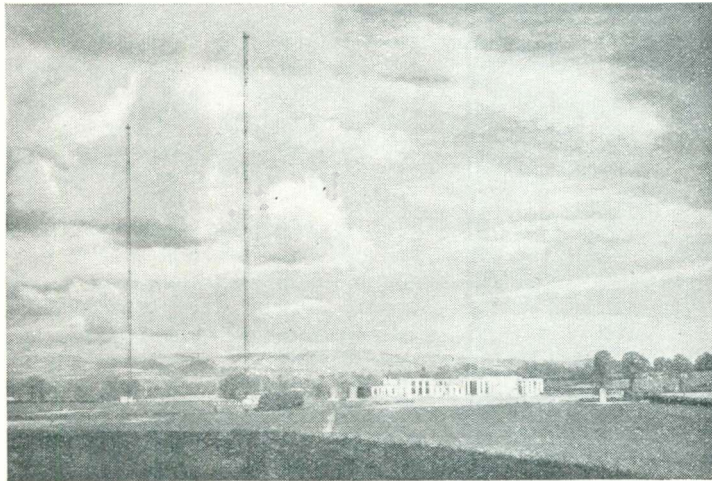

B.B.C. photo
Far more pleasantly situated than any other B.B.C. regional centre is West Regional, which nestles at the foot of the Quantock Hills down in Somerset

produce noises in the ether that are very much worse on the long waves than on the medium. A glaring example of this is the interference caused by trolley buses and trams, which simply blot out long-wave signals altogether, even though they cause no trouble on the medium waves.

The long waves are, then, generally more noisy than the medium waves. The background is therefore likely to be higher when listening to a long-wave station at, say, 200 miles than when listening to a medium-waver at, say, 20 to 30 miles.

Still another objection to the long waves is the need for a reasonably efficient aerial. The mere wisps of wire that serve to bring in a nearby medium-wave national are often nearly useless when asked to bring in a long-wave station at three times that distance—even though

By ALAN HUNTER

who reveals that when the new Midland Regional finally takes the air in the New Year there will be a general re-shuffle of B.B.C. wavelengths. Provided that it can be shown that Droitwich adequately covers the service areas of London, North, and West Nationals, these medium-wavers are scheduled to close down at the same time. Fears of an outcry when these Nationals are shut down are forcibly expressed in this special article

the transmitting power may be very much greater. Nor does that end the general case against the long waves. Sets in general are not so selective on long waves as on the medium, and there is difficulty in keeping a high-power long-wave station within bounds—as many thousands of listeners around Birmingham are finding.

Whereas with Daventry these listeners could manage to log Radio Paris and Luxembourg clear of the home station, they are finding with Droitwich that the whole of the long-wave dial is swamped.

Droitwich is not actually “spreading” any more than Daventry did. Its carrier wave is 200 kilocycles, and its frequency response goes up to 9,000 cycles. It modulates the carrier 9 kilocycles each side, taking up altogether 18 kilocycles frequency in the long-wave gamut.

The point is that the whole of the long waveband consists in the nature of things of only a small frequency range. From Oslo's wavelength to Huizen's, for example, the total frequency difference is only 100 kilocycles. It simply means that any given station normally takes up a bigger proportion

of the whole of the tuning scale on long waves than on medium.

Some idea of the difference between the frequency range available on long and medium waves will be gathered when I mention that from 200 to 550 metres there is a frequency difference of nearly 1,000 kilocycles—ten times that available between Oslo and Huizen.

Many sets that were thought selective under Daventry conditions were not actually so. They responded to some extent to Daventry all round the dial, but not sufficiently to amplify it up as interference when tuned to, say, Oslo or Huizen. Now Droitwich, with its higher power—and, so far as Birmingham listeners are concerned, closer proximity—simply shows up these sets for what they are—inherently unselective.

All the same, the so-called "spread" of a long-waver over the complete dial would, in terms of medium-wave reception, mean the swamping of only a fraction of the dial. If the set responded to the signal when 50 kilocycles off-tune, the total swamping effect would be 100 kilocycles—only a tenth of the total available dial, thus leaving plenty of other stations clear.

Lining up all these points, then, we come to the conclusion that the long waves are not all honey and flowers as a provider of a nation-wide national programme.

Atmospherics, man-made or natural, the need for a good aerial, and the swamping of the dial, all present drawbacks to the idea of a long-wave station like Droitwich replacing medium-wave nationals.

Yet that is the avowed object of the B.B.C. They have, in their Droitwich pamphlet, directly stated that it is proposed to shut down the London, North and West Nationals. Lately the Corporation's statements have been rather more guarded, showing that it recognises the difficulties ahead.

Actually, I believe there will be a great agitation when an attempt is made to shut down London National. Millions of dwellers in the Big City rely for reception on the most ridiculously inadequate aerials—inadequate, that is to say, to do justice to a long-wave

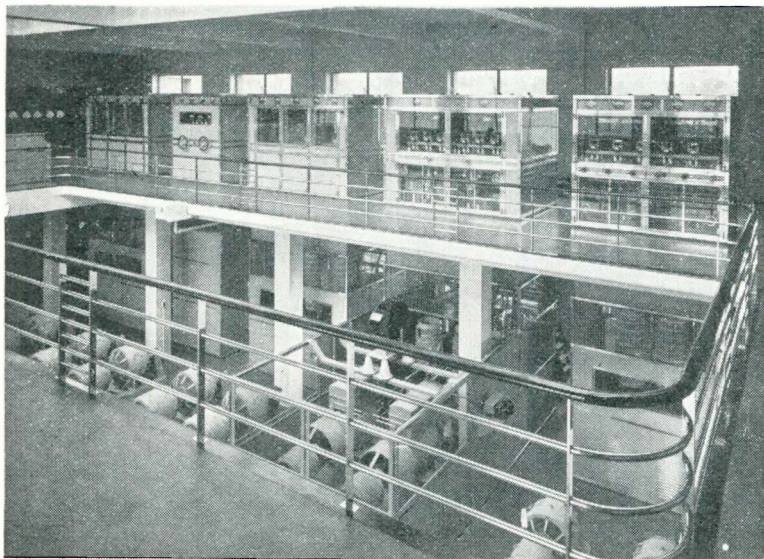

B.B.C. photo

The cause of all the trouble! On the further side of the gallery is the huge Droitwich transmitting gear, the introduction of which is likely to cause the B.B.C. to shut down the North, West, and London National transmitters in the New Year

transmission, though passing fair when tuned to the medium-wave National.

This state of affairs must apply nearly as much in the highly-populated industrial North—if I may judge by some of the aerials I have seen up there—similarly in the western towns.

Successive howls from each of the affected areas may confidently be expected. Worked up by diligent stunt press men, and fanned by the indignant utterances of misguided parochialists, the listening public will suddenly realise that it cannot possibly do without the little Nationals.

Then the fun will begin. I do not envy the B.B.C. the next few months.

Going around as I do, I gain a very fair idea of what the Average Listener is thinking about. At the moment the Big City dwellers are not thinking much about Droitwich simply because they are too lazy to tune up to it. Instead, they go on as usual listening to London National.

When, though, they are made to realise that they must go up to Droitwich or do without a National programme it will be another pair of boots altogether.

It is too early to say exactly what will happen. The original intention was to shut down the synchronised London and West National first, followed into the transmitters' Valhalla by North National. Possibly, in view of all the things I have mentioned—which, of course, the engineers are fully aware of—an attempt may be made to synchronise all three Nationals on one wavelength.

At the moment the need for wavelengths in the B.B.C. scheme of things is not terribly urgent. When the new Midland Regional opens some time between Christmas and the New Year, it will not need an additional wavelength. But there will be a re-shuffle. Midland Regional will lose its present very favourable channel of 391.1 metres, probably to Scottish or West Regional, taking over one of their wavelengths instead.

Wavelengths will have to be found eventually for North Scottish Regional at Burghead, Elgin, and for North-Eastern Regional on a site not yet determined—probably somewhere about 15 miles from Newcastle.

Then, too, there is the Lisburn transmitter now being put up for Northern Ireland. This 50-kilowatt Regional will hardly do very well on Belfast's present wavelength of 267 metres.

From every point of view the need for some rationalisation of our programme radiation system is becoming urgent. Exactly the way out the Corporation will take is not known—even to itself.

On the face of things, some method of synchronisation seems the solution. The difficulty of working stations on the same wavelength when those stations are of high power has unfortunately been all too painfully obvious in the experiment with

London and West Nationals, which share 261 metres.

What I mean is simply this: Might we not go back to low-powered stations for National radiation to the localised areas of dense population—most of which stations could be synchronised on a common wavelength? That would leave the rest of our exclusive wavelengths on the medium band for the existing and new Regionals.

This plan would entail no sacrifice from the more distant listeners to the medium-wave Nationals, who in any case cannot rely at night on the present high-power transmitters. For these out-of-town listeners Droitwich offers a reasonable service—probably a very much better service than they have ever been able to enjoy from their nearest medium-waver.

PERCY W. HARRIS,
M.Inst.Rad.E.

*Explains How to Build
a Portable Testing
Equipment with which
You Can Quickly Try
Out All New Ideas*

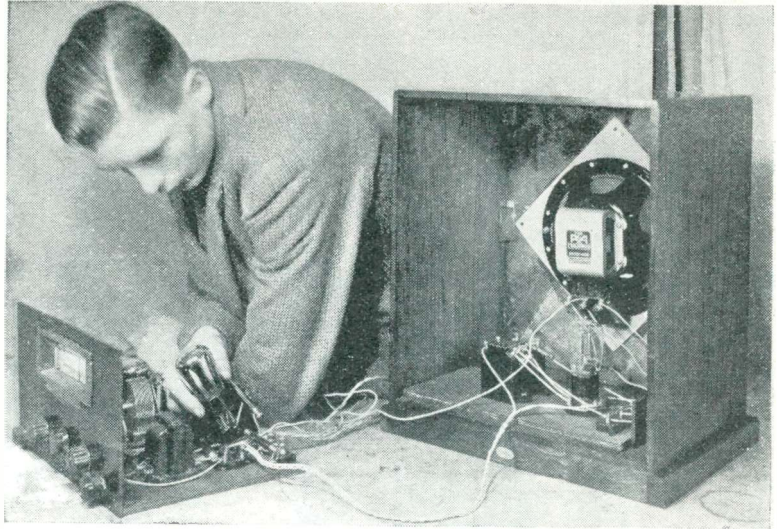

Useful for experimenting is a loud-speaker with a low-frequency amplifier built into the cabinet

How to Start Experimenting

REAL wireless enthusiasts are never satisfied with second-hand information—they like to try out things for themselves. Unfortunately, the great majority of such people are handicapped in both time and space, for few people have a room—or even a table—exclusively reserved for wireless experimenting.

“If Only I Had . . .”

Many an experimenter has said to himself: “If only I had a room to myself entirely devoted to wireless—what wouldn’t I do!” Even in the long winter evenings after one’s work is done and meals have been disposed of, it seems as though, as soon as we have set up everything we want for an experiment, it all has to be packed away again.

Even wireless enthusiasts require some sleep! I remember how heart-breaking it was when I began experimenting a quarter of a century ago, but being in possession for many years of a laboratory, which nobody is allowed to touch but

myself, I have long since found that practically unlimited space does not bring all the advantages it would appear to offer.

Looking round my lab this morning, I asked myself just what could be done in a room of this kind that could not be equally well done in less convenient conditions. On analysis of this question I unearthed several important facts.

The first of these is that in wireless experimental work a much greater proportion of time than you would imagine is taken up with repetition. Improvements do not occur in every part of a circuit at once, and very many units of a wireless set are just about standardised. I have, therefore, found it possible to design a portable experimental bench which can normally be kept in the cupboard under the stairs, or even under a bed, being brought into use on any convenient table at a moment’s notice. Fig. 1 shows the general arrangement.

It consists of a soft deal base-board of any convenient dimensions

with an upright piece fastened by brackets about seven or eight inches from the back. This upright carries a rear shelf six or seven inches wide and the full length of the upright, the carpentry work being such that anyone can knock up the whole affair in a very short time.

Any Convenient Size

There are no critical dimensions—the bigger it is the better, within limits—and one can conveniently utilise any wood that is available. It should, however, be soft wood, particularly for the baseboard.

At the left end of the upright are fitted two terminals for aerial and earth respectively, while L.T.—, L.T.+, H.T.—, H.T.+1, +2 and +3 are the other terminals, which should be set into an ebonite strip in approximately the positions shown in the diagram.

Double Variety Terminals

It is convenient for the terminals to be of the double variety. That is to say, there should be milled heads on both sides of the board for easy connections.

Along the back of the shelf are bored any convenient number of holes about 1 in. in diameter into which the valve pins will fit, thus enabling you to keep handy all the valves you need, while three or four other and smaller holes can be used for keeping two or three screwdrivers of suitable sizes, and a pair of pliers.

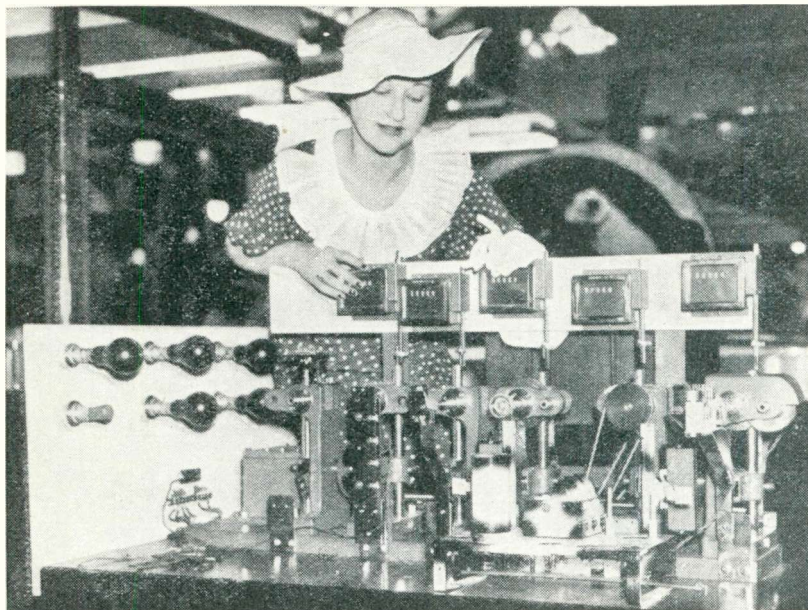

H.M.V. photo

EXPERIMENTING WITH TIME!

This life-testing gear, which was shown at Radiolympia this year, can, in four days, give a radio set the equivalent wear and tear it would have in an average home in six years

At the right-hand end of the upright should be placed a double-pole double-throw tumbler switch, and if you have them, or can afford to buy them, I would strongly recommend you also to screw to the upright a low-tension voltmeter, a high-tension voltmeter, and a milliammeter.

Insulated Leads

To these three instruments should be attached insulated flexible leads terminating in small crocodile clips. When not in use these flexible leads can be thrown over the top of the shelf and will hang out of the way down the back.

The space behind the upright is used for the high-tension battery or batteries and for the low-tension accumulator, the leads from these being connected up to the terminals marked, with the exception of the low-tension negative lead from the accumulator which goes to one side of the double-pole switch, the other side being connected to the L.T. - terminal, and a similar arrangement from the negative of the high-tension battery through the switch to the H.T. - terminal.

By putting the switch in a convenient place, both high- and low-tension can be cut off in a moment if anything goes wrong. It is a good plan also to fix a fuse in the negative high-tension lead.

You have no idea how much time a little bench like this will save. It can be lifted out of its hiding place and stood on any table in a moment, the soft-wood base enabling you to screw any component to it quickly and easily when trying out a new circuit.

Your battery terminals are where you want them; there is very little risk of shorting them; and you have not the eternal bother of searching for battery leads, getting them all mixed up and wondering which is connected to which and so forth.

Two or three valve-holders can be left permanently screwed down to this board if you wish, and when you want to put it away all you have to do is to disconnect the aerial and earth leads from the back of the board, everything else remaining in position until the next experimental evening.

Standardised Units

The next big time-saving scheme I want to suggest is that you should make up two standardised units. The first should be a standard high-frequency circuit, consisting of an aerial circuit with a wave-change coil, a high-frequency valve, and a standard leaky-grid detector circuit according to the diagram in Fig. 2. This unit terminates immediately after the detector, and is so made that it can be attached to any existing or new low-frequency circuit.

The reason for this is that if anything new comes along in low-frequency amplification—some new method of coupling, a new intervalve transformer that you want to try, a particularly novel class-B scheme, a new output transformer, in fact, anything in the low-frequency side—you have a ready-made set, up to the detector, which can be placed on your experimental board at once.

Practical Test Conditions

If some friend or fellow club member comes along to you and says that the So-and-So transformer is much better than the Such-and-Such, you can very quickly prove whether he is right or wrong under practical working conditions.

Another unit I would suggest

is a standard low-frequency type consisting merely of a low-frequency transformer and a pentode output valve connected to, if possible, a good quality permanent-magnet loud-speaker with its own transformer (Fig. 3).

The whole of this unit can be very conveniently mounted inside a loud-speaker box or cabinet, and can be joined up in a moment to the standard high-frequency

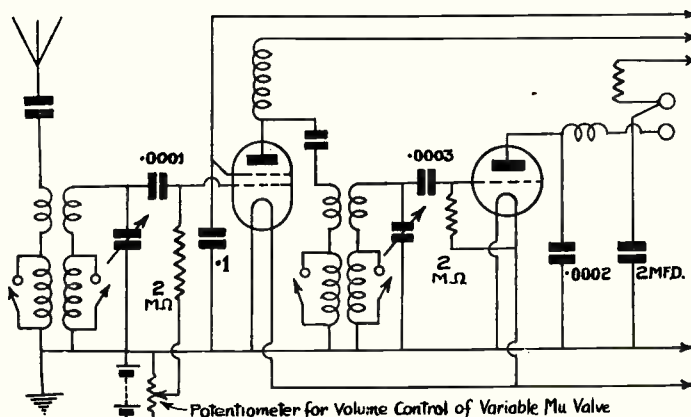

CIRCUIT FOR HIGH-FREQUENCY AMPLIFIER AND DETECTOR

Fig. 2.—A suggested circuit for a standard high-frequency and detector stage to the end of which can be added experimental low-frequency amplifiers

unit, making a complete set with the working of which you will be well acquainted.

The interior of this cabinet should be so arranged that if necessary the loud-speaker can be used alone. With this low-frequency unit always to hand you can try out high-frequency experiments much more conveniently, and with the full assurance that your low-frequency end is satisfactory. You can, if you like, make your low-frequency unit of the tone-correcting variety.

Useful Condenser Block

Another little unit which will save you a great deal of trouble is a fixed-condenser block containing a 2-microfarad and three or four .1 microfarad of the non-inductive type, one terminal of each of the condensers being connected to a common lead (Fig. 4).

Almost all high-frequency circuits today have large fixed condensers somewhere in them, and these condensers are invariably connected on one side to low-tension negative (earth). With this condenser block on your bench and the long common lead connected to L.T.—, you will save a surprising amount of temporary wiring when trying out a new high-frequency circuit.

One of the most useful of all my laboratory devices—I should be completely lost without it when fixing up new circuits—consists

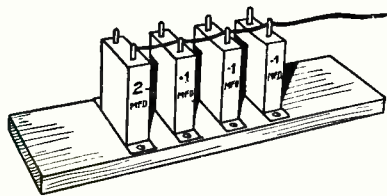

USEFUL CONDENSER ASSEMBLY
 Fig. 4.—A useful unit is made of three or four fixed condensers, one side of each being joined in a common lead for connection to earth

merely of a high-tension battery, a resistance, a milliammeter, and flexible leads connected to two "prodders." In practice, I do not use a high-tension battery, but two 9-volt grid-bias batteries in series, making 18 volts in all.

The milliammeter has a maximum reading of 5 milliamperes, and the value of the resistance is such that when the two prodders are brought into contact with one another the current flowing through the circuit, consisting of the battery, the resistance, the milliammeter and the

prodders, is just within the limit of 5 milliamperes.

If you work it out by Ohm's Law you will find that the resistance in these circumstances should be 3,600 ohms, so if you choose a 5,000-ohm resistance (such a value is easily obtainable) you will be on the safe side. Fig. 5 shows the connections for this outfit, and if you keep the grid-bias battery and the resistance wired up together on a small piece of wood you can always connect this little device to the milliammeter

sealed up in cans. Even the best manufacturers occasionally let slip a faulty coil and occasionally, of course, rough usage in transport may break a connection inside a can.

Checking Coil Windings

By getting hold of the theoretical diagram of the coil and finding what windings there are between which terminals, the continuity or otherwise can be quickly established and the working of the switch checked up.

While on the subject of experi-

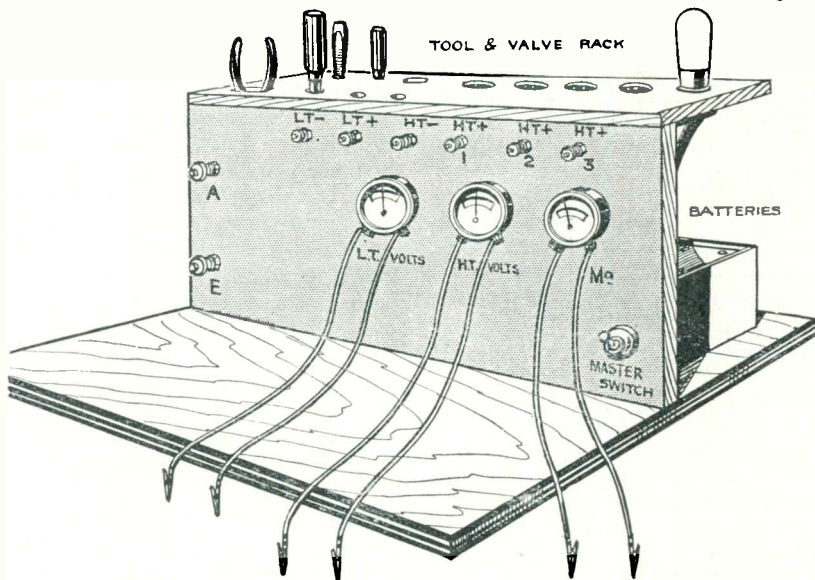

SUGGESTED LAYOUT FOR PORTABLE TESTING BOARD

Fig. 1.—Showing the suggested layout for a test board. On the upright are mounted a row of terminals (which are connected to the batteries behind) two voltmeters, a milliammeter, aerial and earth terminals, and a master switch connected in both high- and low-tension negative leads

on the back of the board (if it is a low-reading type) or, of course, you can indulge in the luxury of a 5-milliamper meter specially for this tester.

The great value of this gadget lies in testing out the continuity of a circuit, for it will show at once whether the primary or secondary of a low-frequency transformer is properly connected up in spite of the high resistance of the windings, while there is no danger of burning out the meter on low-resistance circuits such as those connected to the valve filaments.

You can buy a pair of prodders from several firms, or you can make them up yourself by soldering the leads to a couple of short thin brass rods round which you wind insulating tape except at the ends.

This circuit-testing device is particularly useful nowadays when we have so many complicated coils and multiple switching schemes all

menting may I give you a few hints and tips on circuit analysis? Although it has never been my own practice to take a comparatively simple circuit and draw it in a complicated manner so as to create the impression, together with a lot of ballyhoo, that it is something entirely new, this method is not unknown even in this country. If the circuits, however, are analysed one can soon get down to the real novelties, if any, and here is the way to do it.

Re-drawing the Diagrams

First of all start at the aerial end and re-draw the diagram omitting every possible wire and connection that has not a bearing on the fundamental circuit. For example, in the aerial circuit cut out the aerial-series condenser and all the connections with which are concerned the switching from short to long waves.

Now examine the high-frequency valve and see whether it is a three-

electrode type (which is improbable), an ordinary screen-grid valve, a variable- μ valve, or a high-frequency pentode. If it is a screen-grid valve of the normal type there may or may not be a battery for grid bias.

If it is a variable- μ valve you will probably find a potentiometer for varying the grid voltage and thereby the amplification, the second grid being connected to the high-tension battery, possibly through a

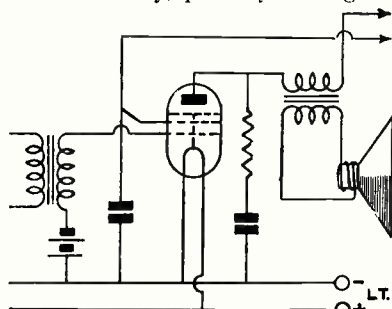

STANDARD LOW-FREQUENCY AMPLIFIER

Fig. 3.—Circuit for a standard low-frequency amplifier using a pentode output valve

resistance and probably shunted to negative low-tension by a condenser. The connections of a high-frequency pentode are very similar to those on the variable- μ valve.

Now examine the output circuit of the high-frequency valve and see whether it is "parallel-fed," in which case the high-tension supply will probably come through a high-frequency choke to the plate, the high-frequency current being bypassed through the primary of a transformer.

Simplest Circuit

In re-drawing this transformer also eliminate anything to do with wave-change and wave-switching so as to come down to the simplest possible circuit. If on either the aerial transformer or the high-frequency transformer or both there is a third winding, it will almost invariably be a reaction winding, and you will be able to trace this back to the particular electrode of the valve concerned.

In the plate circuit of the detector look for and identify the method of de-coupling, and do not confuse this with any resistances used for

resistance coupling. Remember the resistances in a plate circuit may be for low-frequency coupling, or for de-coupling, or both.

If there are two resistances in series with a large condenser shunted to earth from their point of junction, then almost certainly the first one is for resistance coupling (that nearest the detector valve) and the other (between the large condenser and the high-tension supply) for de-coupling.

There is less likelihood to be any complication in the low-frequency end, and in practically all cases the low-frequency part of the circuit consists of one of the well-known combinations, either a directly-fed primary, an indirectly-fed, or a resistance-coupling.

The transformer may either have a separate primary winding, or primary and secondary windings may be joined together to form an auto-transformer, while the valves used in conjunction with the transformer will fall under the headings of (1) single triode, (2) single pentode, (3) pair of valves used in normal push-pull, (4) pair of valves used in class B, (5) single multiple electrode valve used for Q.P.P.

A special transformer may be used with a pair of terminals connected to a potentiometer, so as to vary the characteristics of the transformer and give tone control, or there may be a condenser in series with a resistance (this latter being variable) connected across one of the windings so as to give attenuation of the high frequencies and to alter the tone that way. The output, of course, is nearly always through the primary of a step-down transformer for use with a moving-coil loud-speaker.

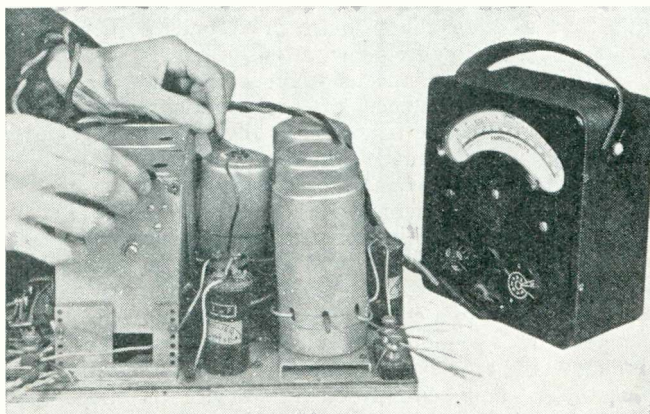

AN INVALUABLE MULTI-RANGE TESTER FOR THE EXPERIMENT
A comprehensive testing instrument giving many ranges of volts, amperes and ohms is the Avometer. It is rather expensive, but a junior version is available at a cost of 40s.

So far I have spoken of "straight" circuits. Super-heterodyne circuits will resolve themselves into more or less high-frequency amplification before the mixer valve, several varieties of mixing valve and circuit (particularly now we have multi-electrode valves), one or more stages of intermediate-frequency amplification, a second detector (which may have nowadays rather a complex method of getting rid of the intermediate frequency out of the low-frequency) and the usual low-frequency stage or stages terminating in the output stage.

Peculiar Connections

Peculiar connections from the second detector away back to the earlier valves are probably concerned with automatic volume control.

Selectivity in a circuit can be obtained in several ways. In a

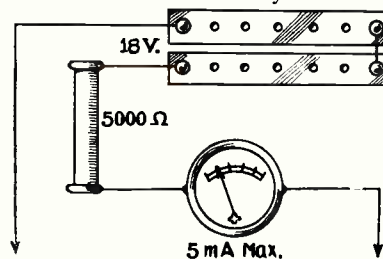

CONTINUITY TESTER
Fig. 5.—Two grid-bias batteries, a 5,000-ohm resistance and a 0-to-5 millimeter make a useful continuity tester

straight circuit we can increase the selectivity by reaction or by increasing the number of tuned circuits. If we have a high-frequency valve preceding the detector valve and we have reaction in the detector circuit, no harm will be done to neighbours listening, for if we should make the set oscillate the high-frequency valve will prevent the oscillations getting into the aerial.

If, however, we use aerial reaction and the set oscillates we shall liberate those squeaks and howls from which, mercifully, we have been comparatively free in recent years.

Another disadvantage of reaction amplification is that the higher the degree of reaction the poorer the quality, unless we constantly readjust the tone-correcting circuit, if we have one.

Is a Transportable Stenode Possible?

By
**PAUL
TYERS**

Following the publication of constructional details of the "W.M." Battery and A. C. Stenodes, several readers have asked if we would describe completely self-contained models. Work on these transportables has been going on in the laboratories of Paul D. Tyers for some time, and here he explains the difficulties that are likely to arise in his experiments

I HAVE received a number of requests to design a transportable Stenode receiver. It so happened that each request was in the form of a question: "Is it possible to make a transportable Stenode?"

Now the answer to this question is, of course, from first principles, very decidedly yes. Whether it is possible to design a transportable set which can satisfactorily be built by the home constructor is an entirely different matter.

Two Distinct Parts

Let me explain why this is actually the case. A super-heterodyne receiver can always be divided into two very distinct parts, the pre-selector circuits, which precede the frequency changer; and the intermediate amplifier, second detector, and speech amplifier.

We know that we have available everything that is required, from the mixing or frequency changer onwards. We have high-frequency Stenode couplers and tone correctors, and, of course, all the necessary low-frequency gear and loud-speaker, together with the power supply.

Essential Relationship

Now an essential feature of the operation of any super-het is that there must always be a definitely maintained relation between the frequency of reception and the

frequency of the oscillator. For this reason special tuning packs have been produced in which the oscillator condenser is ganged with the tuning condensers.

Unfortunately, as far as I am aware, there exists on the market no tuning pack which consists of a frame aerial inductance and an oscillator inductance tuned by a double-gang condenser.

This means that it would appear necessary for the home constructor to make a special frame aerial. This, however, will introduce quite a number of difficulties because the inductance of the frame aerial must be exactly correct or the ganging will not hold good.

If we use a frame aerial instead of the ordinary outside type the voltage which is transferred to the first valve will be very much lower. This means that the signal strength will fall considerably and there will probably be insufficient voltage to give proper automatic volume control action. Here, then, we see we are encountering quite a major difficulty.

It is obvious that we must, therefore, by some means or other increase the overall gain of the set. There are two ways of doing this. First of all we can add another valve, and obviously the best way to use this would be as a signal-frequency amplifier.

H.F. Stage Advisable

This would produce sufficient voltage on the grid of the mixing valve to give efficient operation. In fact, it is a general commercial practice when using a frame aerial to employ an initial signal-frequency amplification stage.

Second Method

The other method of increasing the gain is to tighten the coupling in the high-frequency Stenode couplers. This will tend to decrease the selectivity. It is conceivable that this would not matter so much because enhanced selectivity will be obtained by the use of a frame aerial.

If this method proves satisfactory it would be very convenient, because

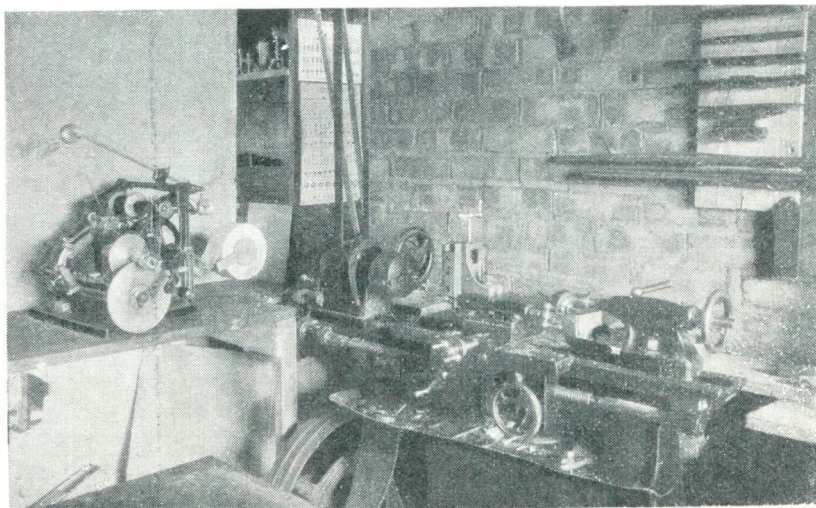

WHERE THE "W.M." STENODES WERE DESIGNED
This is part of the Watford laboratories of Paul Tyers. Development models of coils cannot be made accurately without such machines as those shown in this photograph

Low-frequency Stenode Coupler

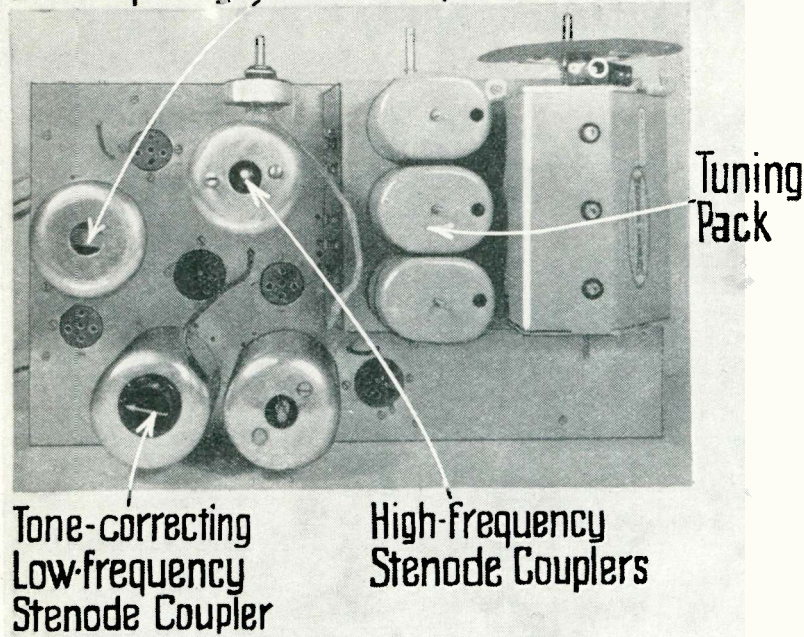

SHOWING THE STENODE COUPLERS AND TUNING PACK

This plan view of the "W.M." Battery Stenode shows clearly the positions of the four Stenode couplers and the tuning pack

it would obviate the necessity of using an extra valve.

I have pointed out, however, that it is essential to obtain the largest possible voltage on the grid of the mixing valve, and it is very doubtful whether the receiver would work properly without the initial stage.

Practical Solution

It would appear, therefore, that the real practical solution to this problem would be to use a standard commercial tuning pack consisting of coils suitable for an input high-frequency stage and oscillator. The input coil, however, will have to be removed and it must be substituted by a frame aerial, and the inductance of this will have to be matched exactly to the inductance of the high-frequency coil.

Actual Experiments

Actual experiments are being made with both the suggested systems, and it is quite possible that the simple arrangement without the additional valve may give good programme strength from a sufficiently large number of stations to warrant designing a receiver on these lines.

It must be remembered that the selectivity and sensitivity of the Stenode which I designed some

months ago is such that it is by no means difficult to receive seventy to eighty stations.

The whole subject raises a rather important point which should be of interest to the home constructor. Why, it may be asked, is it necessary to make a practical experiment on the merits of the two systems when it should be possible to predict the

result from pure theory? One can calculate the selectivity and the stage gain, and as a result one should be in a position to state immediately what performance would be given by the two types of sets.

Question of Stability

This reasoning is quite sound up to a point, but it overlooks one very important factor. This concerns the vital question of stability. It is by no means easy to stabilise a frame-aerial receiver. It is hard enough in a factory-built set, but it is infinitely harder in the case of a receiver put together by the home constructor.

As a result one has to lower the overall efficiency to give an ample factor of safety, because a receiver is obviously no good *unless it is going to be completely stable under all conditions.*

Impossible to Calculate

This factor of safety is the one thing which it is almost impossible to calculate theoretically. Much depends upon the actual physical dimensions and the relative positions of the proprietary components, which one must of necessity use in the construction of a set.

It will be seen, therefore, that it is impossible for me to say whether a satisfactory transportable Stenode can be built until the experiments referred to have actually been completed. These experiments are now being made in my laboratory.

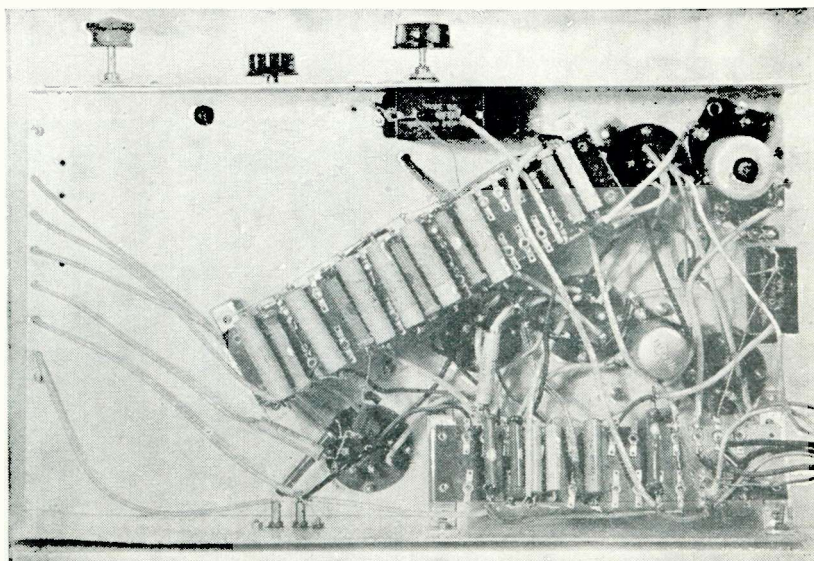

UNDERSIDE VIEW OF THE BATTERY STENODE

If you look at this photograph and the one at the top of the page, you will see that the set chassis of the Battery Stenode consists of little more than the tuning pack, Stenode coupling coils and two strips on which are mounted the resistances and condensers

News of the Short Waves

By **KENNETH JOWERS**

IT seems to be the general impression that reception conditions at the moment are as good as they have been for many months. All correspondents make particular mention of the lack of atmospherics and the ease with which American stations can be tuned in *quite early in the afternoon*.

One enthusiastic reader constructed a simple one-valver on an aluminium chassis, and within two hours of having *started* to build the set, he had logged three American stations.

He doesn't know what particular stations they were because the receiver was not calibrated, but there was no question about the accuracy of the reception.

A correspondent from Exeter tells me that the Australian station VK3LR is coming in very well indeed on Sundays round about 0815 on 31 metres. On the 20-metre band in the same locality W stations come over from mid-day.

This is surprisingly good, but after 7 p.m. this band goes absolutely dead. Those readers who complain about lack of reception on the 20-metre band should make a note of this.

Among stations heard in Devonshire are HI7G, HI8X, W1DVR, W2AND, W3WDO, W8ANN, the Canadian VE2DX, W1DBL, W3BPH, W8BAE, and the Cuban CM2RA. All these were logged on 20 metres using 'phones. Don't ignore the 80-metre band for amateur 'phones. Several Americans are coming over on this band, strength averaging R7, but only early in the morning before breakfast.

I was glad to receive a letter from H. J. Barlow, of Gorton, Manchester, who uses a simple detector and 2 L.F. receiver on a 66-ft. indoor aerial. Since January he has logged 655 American amateurs and over 820 stations from different parts of the world.

Conditions appear to be good in the Manchester area, for among some of the stations heard were the South Americans LU1EP, HC2RL, CX2DI, while during the past few weeks, eighty-six Australian and New Zealand stations have been logged including VK2VQ, VK7RC, VK3MR, ZL3GM, ZL2GN, and our old friend ZL4AO.

I notice that the Japanese station J2GX has been logged by several readers on the 20-metre band round about 2100 onwards.

During the last week in November and the first two or three weeks in December, Australian and other stations in that direction will be coming over between 0630 and 0800 on 40 metres and from 1200 to 1400 on 20 metres.

Manchester readers should make a particular note about 20-metre reception conditions of American stations. In Devonshire this band shuts down at 1900, but the best times in the North of England are from 1400 to 2300.

BRS1544, Norman C. Hobbs, of Birkenhead, sends me a very similar log to Mr. Barlow. He has received half a dozen Australian and New Zealand stations, but finds that



Short-wave working brings you into touch with people all over the world. When amateurs send radio reports they frequently send photos of local scenery, such as this delightful view of a Japanese river, which was sent by an enthusiast to the author

although conditions are quite good, one has to be very careful about choosing the proper waveband and the correct time of the day.

For example, the CM, K5 and LU stations come in between 0200 and 0500 on 40 metres. The VK and ZL's between 0600 and 0900 on 40 metres, and 1400 and 1500 on 20 metres.

The Africans are usually on between 1800 and 2000 on 20 metres, while the W5, W6 and W7 Americans usually come over after 1900 on 20 metres.

Mr. Hobbs makes the suggestion that it would be a good idea to gang the reaction condenser with the tuning condenser and adjust these so that as one increased the tuning the reaction would automatically be increased. To overcome any variations in choke efficiency, and the amount of reaction required, he has another reaction condenser in parallel with the ganged condenser and controlled independently.

In this way he says the receiver is always in its most sensitive state with a consequent simplified tuning.

Anyone who has tried this system please drop me a line.



Still in bother, by the look of it. Clapham and Dwyer discussing the plans for some house or another!

A week before Christmas, on December 18, there is to be the now annual relay of the Nativity play, *Bethlehem*, from the old church of St. Hilary down in Cornwall. This is perhaps the sincerest part of these programmes; the play is performed by the villagers themselves under the direction of the rector and, I believe, Filson Young.

On the day after, at 8.30 p.m. in the Regional programmes, is a performance of Sullivan's *Golden Legend*—old-fashioned, some of us will say, but nevertheless charming! By the way, on the other wavelengths there will be at 8.30 p.m. another relay of a Chopin piano recital from Warsaw. A European link-up this!

News About the Xmas Programmes

By T. F. HENN

I HAVE before me on a small scrap of paper a rough outline of the B.B.C.'s projected arrangements for the Christmas programmes. If I were in a liverish mood I should probably start pulling them to pieces. But I am in a wonderfully good mood, and I cannot refrain from shouting with joy at the prospects of those poor souls who will be spending the season alone with just a radio receiver to entertain them.

To cater for millions is a horribly difficult job; I certainly wouldn't like to be the man upon whose shoulders rests this great responsibility. To cater at Christmas for these millions must be more than difficult. It is a task beyond the cleverest B.B.C. programme arranger. And for this simple reason. A lone listener relies solely on radio for his Christmas entertainment; and what would suit him would not agree with a whole party of listeners together.

To be quite frank: if you are holding a party, thoughts of radio would hardly enter into your mind unless it be for just ordinary dance music. The individual listeners, to my mind, are going to have a really jolly time this Christmas.

Let me straighten out this now horribly crushed scrap of paper and

run through these programmes briefly. "W.M." has many hundreds of readers out abroad and this information may be their only guide.

Chopin at its best, probably, but I prefer the piano recitals from the British studios mainly on account of the better quality of transmission.



Two favourite broadcasters—Ethel Bartlett and Rae Robertson, who broadcast duets on two pianos

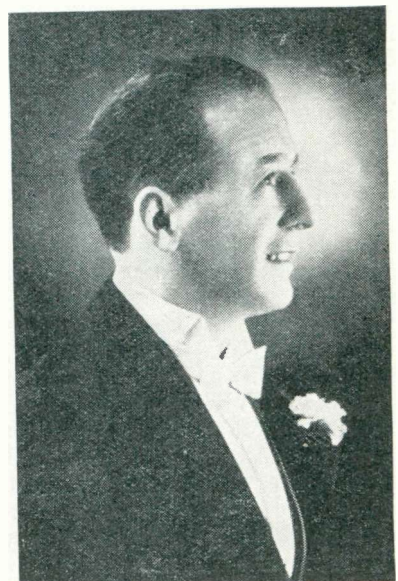

Real good dance music is provided by Bertini and his band whose music is relayed from the Tower at Blackpool

The Chopin recital by Solomon in November was all that I would wish.

On December 21 Philip Ridgeway makes one of his rare parades before the mike. Keep the effects down, Mr. Ridgeway, and I will thoroughly enjoy your show!

A real piece of Christmassy music is down for the 23rd—part 1 of Handel's *Messiah* with B.B.C. Orchestra and Chorus, with Dr. Boult conducting and Stiles Allen, Margeret Balfour and Tom Pickering as soloists.

On December 24 at 3.30 in the afternoon is the high spot of the



One of Britain's best bass singers, Norman Allin, is a frequent broadcaster

religious side of Christmas broadcasting—the Carol Service from the Chapel of King's College, Cambridge. If you get the chance to hear this, do so; the singing and the atmosphere are really delightful.

Christmas Day programmes open with a relay from St. George's Chapel, Windsor, in the morning (10.45) and this is followed at midday by an assortment of cinema-organ and orchestral music of a light kind lasting throughout the afternoon, with the exception, of course, of the big Empire link-up at 2 p.m., when His Majesty is broadcasting Christmas greetings.

In the evening there will be more cinema-organ music, the first performance of the broadcast pantomime—this year it is *Bluebeard*—music by a chamber orchestra and dance music to wind up the evening.

On Boxing Day there will be the second performance of *Bluebeard* at

7.30 p.m., a recital by the famous 'cellist, Suggia, with Kate Winter, soprano, at 8.45, followed by the Leslie Bridgewater Quintet at 10—all on the National wavelengths.

The B.B.C. has really excelled itself for Boxing Day Regional programmes. At midday there is a



A popular radio comedian is Alec McGill, who broadcasts with Gwen Vaughan

recital of specially chosen records, Northern Orchestra, and a band. In the evening Henry Hall starts the proceedings at 6.30 with an hour's dance music, followed by Arthur Fear and the B.B.C. Orchestra at 7.30, Kentucky Minstrels at 9.0 and the Second News and more dance music at 10 p.m. Dance music on both days will last until midnight.

I think the B.B.C. might have made an exception and continued it until 1 a.m., but time is early yet and some alteration in timing may yet be made.

In Christmas week there will be two performances of Dickens' *Oliver Twist*. Times for this are not yet settled, but I hope it is early for the kiddies' sake.

December 5 is a great day for Manchester and district listeners. In the evening the big 119-strong B.B.C. Symphony



This comedian turns out really good radio material—Leslie Sarony

Orchestra is making its first provincial appearance—this is at the Free Trade Hall.

You remember that last month I told you that this orchestra was making a round of the large provincial centres. Arthur Catterall will be leading the orchestra as usual and this will no doubt delight the Hallé regulars of the Free Trade Hall for Catterall was, for many years, the leader of the famous Hallé Orchestra.

Anyway, we can share in Manchester's enjoyment for the concert,



These two duettists, Johnny Walsh and Jack Barker, hail from America. They were on the air recently



Leader of the famous quintet that bears his name, Cedric Sharpe

which is an especially good one, will be broadcast. The programme opens with Wagner's overture to the *Mastersingers*. Then follows Strauss's tone poem, *Ein Heldenleben* with Arthur Catterall as soloist. The rest of the programme is made up of *Mai-Dun*, a stirring symphonic rhapsody by John Ireland, Paul Hindemith's *Philharmonic Concerto* and, finally, the great *Bolero* by Maurice Ravel. Manchester people will enjoy this last work; it is a great musical joke!

John Watt is very much in the news these days. At the time of writing he has just finished his *Songs from the Films* series and is busy compiling the next series, which will go under the title of *Songs from the Radio Shows*. As far as possible the songs will be sung by the artists who first introduced them.

But that is not all. These "songs from something" programmes take a tremendous amount of preparation and already John Watt has ideas for two further series. One is another series of *Songs from the Films*. Mr. Watt is also working on an interesting idea for a series based on *Songs from the Shows* but with contrasting composers.

That needs a little explanation, probably. What Mr. Watt intends to do is to take a song on a certain subject and show how it would be treated by such composers as, say, Gershwin, Lionel Monckton, Youmans or Talbot. These new series are worth looking forward to!

Ship-launching ceremonies are becoming a feature of outside broadcasts. On December 7 the Duke of Gloucester, in Melbourne, is launching by means of radio the new Orient liner *Orion* from the Naval Construction Works of Vickers Armstrong, Ltd., at Barrow-in-Furness.



A world-famous character artist who usually broadcasts at Christmas, Bransby Williams

Listeners will hear a speech by the Rt. Hon. Stanley Bruce from the launching platform, then the Duke's speech from Melbourne; a running commentary on the proceedings will be given by Commander D. A. Stride.

The new liner has a displacement



With his *Parade and effects*, Phillip Ridgeway will broadcast a show in December programmes

of 24,000 tons—a really big ship—and she will have only a single mast and one big yellow funnel!

It is quite a while since I gave any real praise to the B.B.C. I do want to put on record my appreciation of their late-evening programmes. The material is well chosen. All I want now is to see these programmes extended from 11.10 to 11.30 p.m.

And, by the way, something ought to be done about the Sunday afternoon programmes. We badly need an alternative to the usually dreary material put out between 3.0 and 4.0. The only alternative is the Continental stuff—and one can easily tire of that!

And now for a scrap of really good last-minute news. It is nearly a year since Gracie Fields appeared before a B.B.C. "mike"—I am not counting the night when she appeared for a few brief moments in a Saturday-night Guest programme.

December 5 is the day to remember, for then Gracie will be heard in a relay from the Hippodrome at her home town, Rochdale. There will be some fun that night. I do not know the time, but make a note that the show will be broadcast in the London and North Regional programmes.

Gracie Fields—as you know—was born in Rochdale and began her career by appearing at one of the town's cinemas.

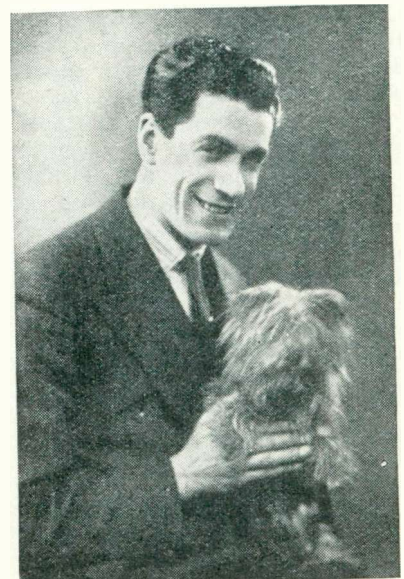

One is always assured of a versatile ten minutes when Mario de Pietro, with mandolin and banjo, is on the air

Here we present an article by MORTON BARR who shows how, apart from broadcasting, radio has taken an active place in everyday affairs. He shows us how radio is used as a means of navigation at sea and in the air; as an unseen lighthouse; and even in surgery and in preserving food. Photographs illustrating this article are by courtesy of Marconi's Wireless Telegraph Co.

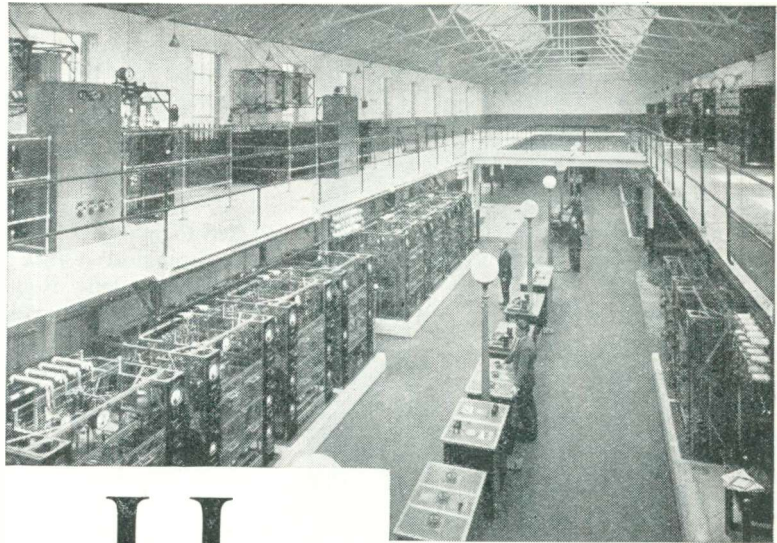

This is the main transmitting hall at the Ongar station, which operates on short waves with all parts of the world

How Radio Helps the World's Work

By MORTON BARR

TODAY wireless is so closely associated in the popular mind with broadcasting that the two words have almost come to mean the same thing. Not that there is any harm in this, except that it rather tends to overshadow the importance of the part played by radio science outside the field of entertainment.

Wireless, in point of fact, first proved its worth in the mercantile

marine. What it did—for the first time in human history—was to provide a flexible line of communication over long distances that kept ships at sea in touch with the land, and with each other. More particularly it enabled a ship in distress to call for help in time of need.

Even if broadcasting had never made its appearance, this would have been sufficient in itself to place wireless on a permanent footing among

the major inventions of the century.

The loss of the *Titanic* with over 1,500 lives was followed by regulations which made it compulsory not only to install wireless apparatus aboard every ship over a certain tonnage, but also to maintain a constant watch so that the S O S appeal should not go unanswered.

“Watch-dog” Device

It is known that as the *Titanic* went down, another liner—the *Californian*—lay only a few miles away.

It was fitted with wireless, but the operator had gone off duty a short time before the S O S signal was sent, and so the appeal fell on deaf ears under circumstances where prompt assistance would have meant all the difference.

Smaller ships not compelled to keep the twenty-four hour watch are now fitted with a “watch-dog” device, which is switched into circuit when the operator goes off duty. This is designed to sound an alarm automatically as soon as the S O S signal is received. Once the alarm is operated it can only be silenced by means of a switch in the operator's cabin.

Lower Insurance

Although safety at sea is generally reckoned in terms of human life, it has a more prosaic side. For instance, part of the cost of carrying seaborne goods is represented by insurance charges, and anything which helps to lessen the risk of transport serves to lower the insurance premium.

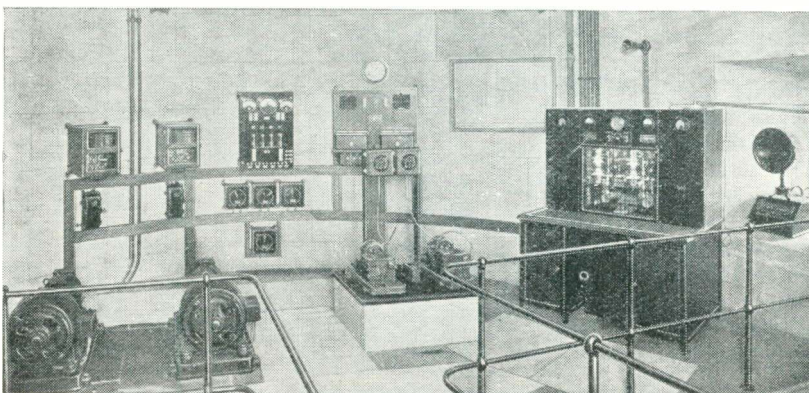

AUTOMATIC BEACON INSTALLED IN A LIGHTHOUSE

This automatic beacon is installed in the Dungeness Lighthouse on the Sussex coast. These beacons are a great help to ships navigating close to the coast

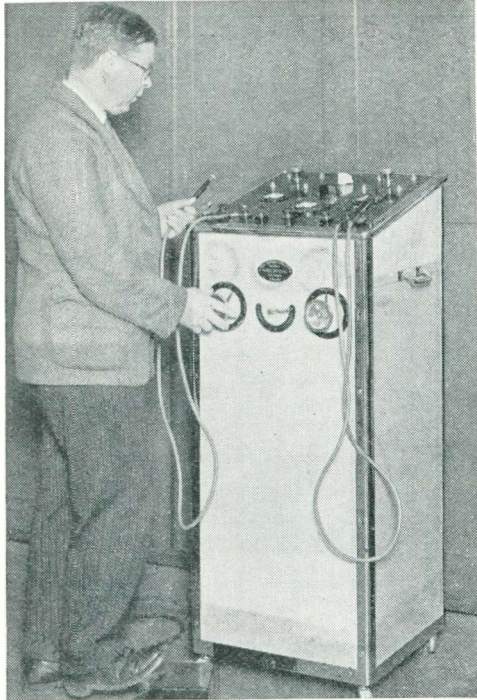

RADIO FOR THERAPY AND SURGERY
 Many hospitals use this Marconi-Dean valve diathermy apparatus. The output of high-frequency energy at the terminals is 240 watts

This may perhaps seem a small point, but taken in bulk the added security due to the use of wireless in the mercantile service has saved millions of pounds in freight charges alone.

Weather Forecasting

Sudden storms are one of the many perils incident to the sea, and a timely warning sent by wireless may make all the difference to the safety of a vessel. But to do this the weather experts must have sufficient data to forecast the location and track, say, of an approaching hurricane.

Before the introduction of wireless, weather forecasting was a much more "chancy" and speculative affair than it is today, chiefly because the sources of information were relatively scanty.

Collecting Reports

Reports of local conditions could only be obtained from such points as were connected to the Meteorological Office either by landline or by submarine cable.

Nowadays, thanks to the new flexible line of communication, systematic reports are constantly being received, both from ships at sea and from a widely distributed network of wireless stations ashore.

These reports state the local temperature and barometric pressure, the humidity of the atmosphere, the direction and velocity of the prevailing wind, cloud conditions, and state of visibility.

All these, when collected together, enable the Meteorological Office to issue their Daily Report, which has now a deservedly high reputation for reliability. Credit for this belongs very largely to the improved facilities afforded by wireless.

Weather bulletins are transmitted at stated periods by wireless for the benefit of navigators at sea and in the air, and for the information of farmers and the community in general.

Fog is another particular peril of the sea—as well as of the air—because it renders useless the elaborate system of buoys and lights upon which the navigator normally depends for his safety.

In this connection direction-finding by wireless introduces a new aid which can be relied upon no matter how thick the fog may be, or how poor the visibility.

There are various systems of direction-finders in use, some of which require special equipment on board the ship, whilst others are designed to allow the navigator to pick up his bearings on any standard type of receiver.

In the first case the wireless operator depends upon a frame aerial to locate the direction of two different land stations, whose position he knows from their characteristic call signal.

He then lays out both sets of bearings on a map, so that the intersection of the two lines gives

him his own position at sea. The frame aerial may be rotatable, or it may be of the fixed Bellini-Tosi type with a movable search-coil.

If the ship carries no directional apparatus, it transmits a wireless message in the ordinary way asking two land stations to send back its bearings as determined by their direction-finding apparatus. From the information received the ship's navigator is again able to locate his own position on the map.

Wireless Beacons

For coast work, small wireless transmitting beacons are set up at shore positions which play a great part in navigation. These send out a continuously-rotating beam which is modulated, first with an identifying "call" signal, and then with the various points of the compass as the rotating beam swings through north, east, south, and west.

Talking Beacons

The Cumbrae lighthouse is fitted with a "talking" wireless beacon which works in combination with a foghorn. As soon as the navigator hears the fog signal, he listens on a pair of headphones to a voice telling him how far he is in miles from the lighthouse.

The scheme depends upon the

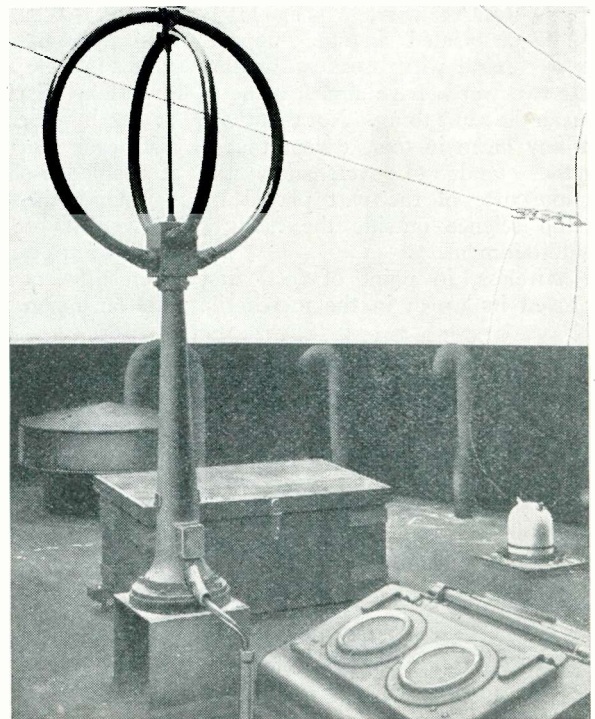

DIRECTION-FINDER IN A FUNNEL
 Strange as it may seem, this Marconi direction-finder is fitted on the top of one of the funnels of the Cunard-White Star liner "Georgic." Incidentally the wireless cabin on this ship is in the body of the funnel

length of time taken by the sound from the fog signal to reach the ship, as compared with the instantaneous passage of the wireless voice.

Over 5,000 ships are now fitted to take advantage of the various direction-finding land stations and the 200 automatic wireless beacons which have been erected to assist in coast navigation. Most of the latter are of the "unmanned" type, being set into operation at definite intervals by means of clockwork.

Blind Flying

The value of wireless as an aid to marine navigation applies with still greater force to the flying services. By means of long-distance wireless beams, the pilot of an aero-

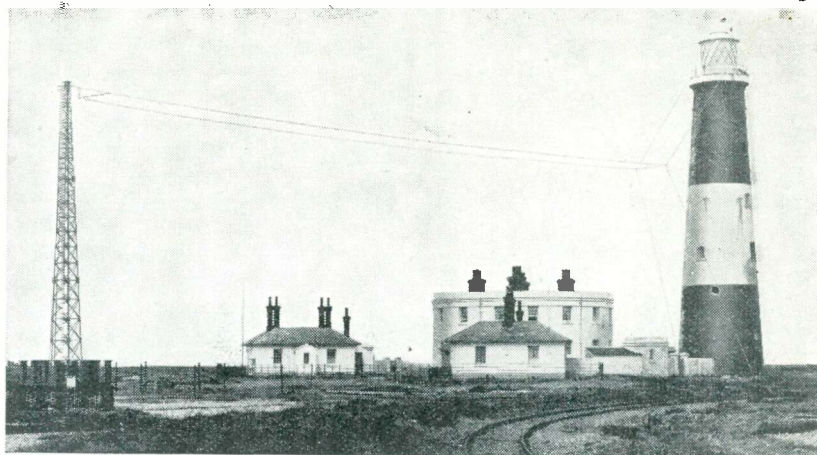

RADIO AT THE DUNGENESS LIGHTHOUSE

A general view of the Dungeness lighthouse where an automatic beacon is installed. The beacon aerial mast is seen on the extreme left of the picture

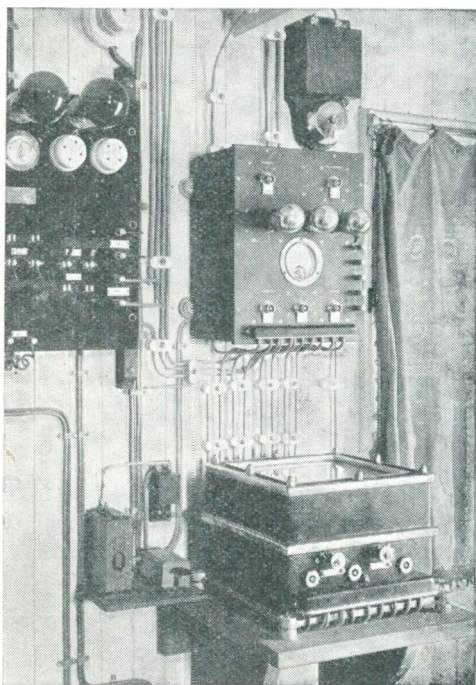

VALUABLE SAFETY DEVICE

Part of the radio cabin on the liner "Marcharda" showing the auto-alarm device. This instrument is capable of picking out SOS calls from a conglomeration of Morse signals. If a call is located it sets a bell ringing

plane can be directed along his course from beginning to end of the flight.

As he reaches his destination a short-wave radio "beam" guides him down to earth at the correct landing-angle, so that, if necessary, he can practically "fly blind" with safety, either at night or in the thickest fog.

Although in its early days radio communication was not a serious rival to the ordinary telegraph and telephone, the commercial side of wireless has grown enormously

within the last few years. It is now constantly used both for long-distance inter-continental traffic, as well as over the comparatively short-range network linking the various European countries.

In this country Ongar is the chief transmitting centre for European traffic, whilst long-distance Beam stations are located at Dorchester, Rugby, Baldock, Bridgewater, Grimsby, and various other points.

Modern methods of producing and handling "dwarf" waves—only a few centimetres long—are rapidly opening up another new field of radio development.

For the moment such waves are being used chiefly for short-range signalling across the English Channel and between other points which cannot conveniently be connected by landline or submarine cable.

The latest Marconi apparatus, which enables a ship to be navigated safely through an intricate harbour-approach in the densest fog, uses wireless waves less than a metre long.

The transmitting aerial is arranged to produce a directive beam which is fan-shaped over a narrow angle. The right-hand side of the beam is modulated by a high-pitched note, which changes to a low-pitched note on the left-hand side. The change of note takes place along the centre

line—and this marks out the course to be followed by the ship.

Actually the navigator steers so that he follows what may be called a "zone of silence." If the ship goes off to starboard the navigator hears a high-pitched note and corrects his steering accordingly.

Needle Steering

Similarly any deviation to his port side produces a low-pitched note on the 'phones. More conveniently a visual indicator can be used, in which case the correct course is shown when the needle keeps at zero centre. This new aid to navigation is sufficiently sensitive to detect an error of half a degree.

Finally, there are a host of interesting radio applications quite apart from what may be called "long-distance" work. In medicine, for instance, short-wave energy is being used for curative purposes, as well as for "bloodless" surgery.

For Preserving Food

Recent electro-chemical research has shown its value in the production of those vitamins which are so essential to health. It is also being used to preserve food by killing off the bacteria which produce putrefaction and are otherwise dangerous to human life. Similarly it can be employed to exterminate certain types of pests or parasites which infest fruit, vegetables, and other plant life.

Wireless, in short, is pulling its full weight in the world's work—as well as providing us with entertainment when our own day's work is done.

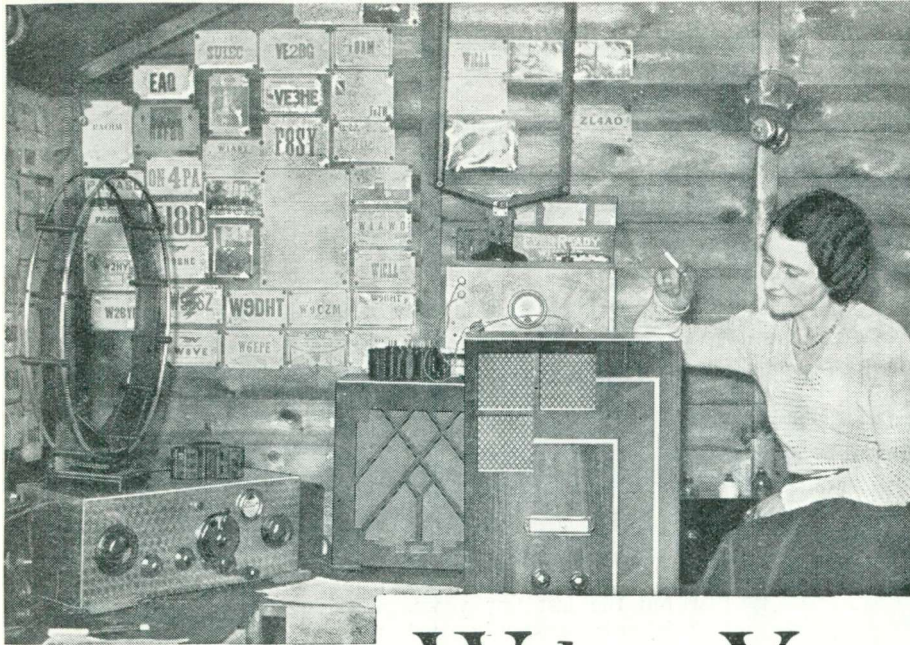

A corner of the author's short-wave laboratory. Note the QSL cards which adorn the walls!

By
**KENNETH
 JOWERS**

What You Should Know About Short-wave Design

ALMOST every article dealing with short-wave receiver design, the operating of short-wave sets, or the other phases of short-wave technique, invariably deals with the common difficulties without pointing out how simple it is to put them right. There are troubles, but none so large that it cannot be overcome.

One of the biggest snags is the inability of the constructor to grasp the idea that a simple one-valve set will bring in programmes from all over the world. The basis of the trouble appears to be the belief that a one-valve broadcast set, having such a limited range, cannot possibly tune in, say, American stations.

In view of this, how is it possible for a short-wave set to be so vastly superior when the fundamental circuits of the two receivers are almost identical?

Hundred-and-one Forgotten Points

From time to time we publish typical theoretical circuits giving the basis of receivers so that technical constructors can build them without having to bother about experimenting with component values. We also give original circuits that have been developed and have some particular advantage over the usual Reinartz or Hartley arrangements.

The difficulty about these circuits is that instead of realising just what the set is intended to do, the constructor goes about assembling the receiver in the same way as he would his normal broadcast set. The hundred-and-one little points which are so important for satisfactory short-wave working are forgotten and, consequently, after the receiver has been used a little while,

Here we present the first of a series of articles explaining the difficulties that occur with short-wave listening and showing clearly how to rectify them. This series will cover every aspect of short-wave reception and will be written in a simple way so that the beginner will be able to get the best out of short-wave listening.

it is either condemned as being inefficient or else short waves are considered a swindle.

This applies to about two-thirds of home con-

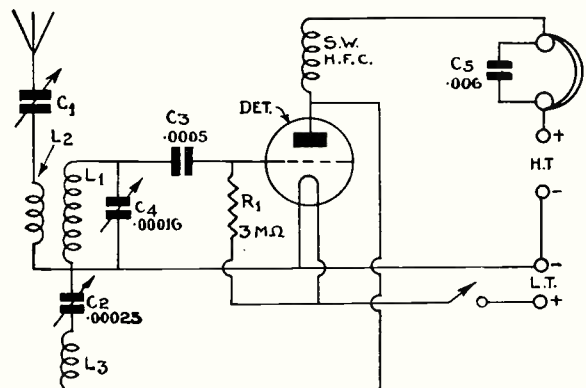

Fig. 1.—A circuit of a simple one-valve short-wave headphone receiver, the construction of which is described in this article

structors or would-be short-wave listeners and, unfortunately, as the troubles they experience are of such a minor nature, it is very difficult to explain just what has to be done to obtain satisfactory results.

A short article can only deal with some of the difficulties that are likely to be experienced, so I intend to go a step farther than that and write a series all about the little snags that other readers have come up against or the points that I have noted when making a new receiver; in fact every little intimate detail which is likely to help the would-be short-wave listener.

What You Can Hear

My actual experiences with different types of receivers and suggested circuits you should try will also be given. Before you start on the construction of your short-wave set, make yourself believe that the readers' reports which have been published from time to time are actually true.

Any simple receiver will enable you to tune in the stations which other readers in all parts of the country are hearing every day. If you think that it is impossible to hear America on one valve, just build a receiver and find out. It won't cost much and you will be surprised!

Compared with the position this time last year there are now several firms who can supply short-wave components of all kinds. That is for the benefit of lazy people, for most of the small components, such as coils and high-frequency chokes, can be home-made with a great saving in cost.

Simple One-valver

It is advisable to start with a simple one-valve set. This is very cheap to build, running costs are negligible, while with a little care it is possible to receive stations from all over the globe.

Take for example a simple circuit such as that shown in Fig. 1. The components are few, some of them can be taken from an old broadcast set, or can probably be found in your junk-box. C_2 , the grid condenser, C_3 , the condenser across the headphones, and the

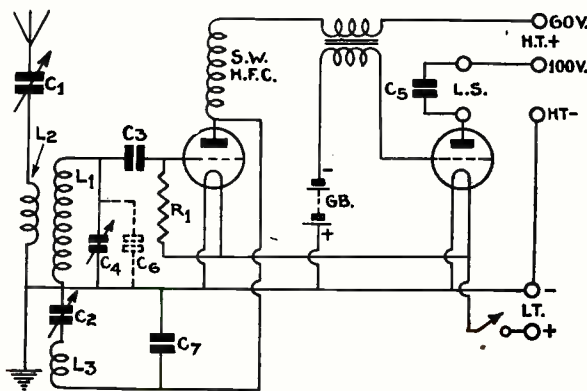

Fig. 2.—The circuit for the one-valve short-wave receiver with an added stage of low-frequency amplification

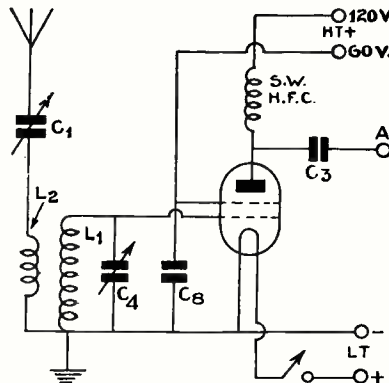

Fig. 3.—Basic circuit of a high-frequency amplifier for adding to the detector stage shown in Fig. 1

filament switch are typical examples of unimportant components. The grid leak, a 3-megohm type, is rather a high value, but is not an unusual value to have by you.

Four Important Components

The four really important components are C_1 , C_2 , C_4 and a high-frequency choke. These values remain constant for all short-wave sets. They can be varied if the actual components are not available.

The three tuning coils, L_1 , L_2 and L_3 , are used in every

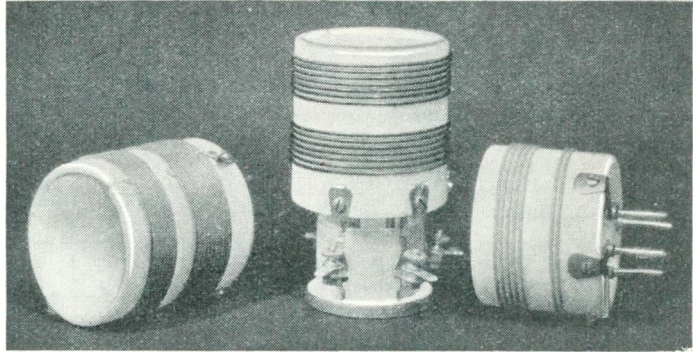

A set of short-wave coils on fused quartz formers. These coils are particularly efficient on ultra-short wavelengths

short-wave receiver. The important one is L_1 . This is the grid coil and it governs the wavelength to which the receiver tunes. For example, an eight-turn coil of about 2-in. diameter, with $\frac{1}{8}$ -in. space between each turn, will bring in the 50-metre-band stations at about 120 degrees on a 180-degree dial using, of course, the .00016-microfarad condenser.

The reaction winding L_3 , should consist of about five or six turns again on a 2-in. former and unspaced. You can experiment with this coil without really knowing anything about it. If you find that the receiver will not oscillate, or will only oscillate on one section of the dial, you can either decrease the gap between the grid coil and the reaction coil, or else you can increase the reaction turns.

Reversing Matters

On the other hand, should you find the set is in a continual state of oscillation, just reverse matters and increase the gap or decrease the number of turns on the reaction coil.

The winding L_2 , is optional. Some people are of the opinion that it is better to connect the aerial directly to L_1 as this gives better volume. That is purely a matter of personal taste. It may give better volume, but on the other hand, with a lengthy aerial the receiver will probably be unselective, and that will be hopeless for at the present time all of the popular short wavebands are very congested.

Suggested Data for the Coils

I suggest that you make L_2 with about three turns and wind it so that the first turn is about $\frac{3}{8}$ in. from the beginning of the grid winding. If you find that the set is then too selective, you can make L_2 with four or even five turns. It is quite a matter of experiment. Of

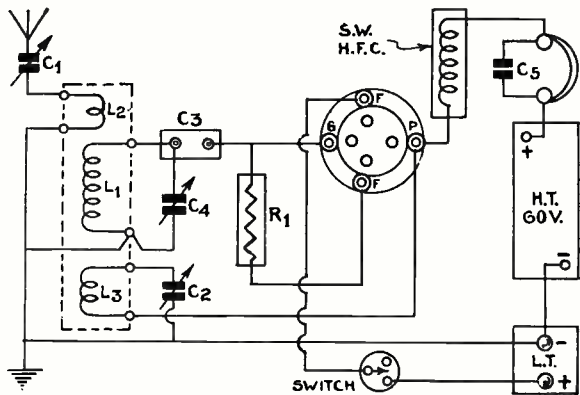

Fig. 4.—Showing in diagrammatic form the wiring for the one-valve short-waver

course, the number of turns on L_2 increases in proportion to the number of turns on L_1 .

It is a big advantage on a short-wave set to adjust your coils so that they cover just what wavebands you require, while you can increase or decrease your selectivity according to the length of your aerial or local conditions.

Making Your Own Choke

A short-wave choke costs about 7s. 6d., but this sum can be cut down if you are prepared to make your own choke at home. It is a very simple job, while the bits and pieces are not hard to buy.

From any chemist you can get a test tube $\frac{1}{2}$ in. in diameter and 3 in. long. It will cost you 2d., and make quite sure it is complete with cork. Then from the local ironmonger's buy a 2d. stick of Chatterton's compound — it looks like black sealing wax. Finally an ounce of 34-gauge wire from the local radio dealer.

Wind on 200 turns of wire on this test tube. You can fix the beginning and the end of the winding to the glass by the Chatterton's compound. If you leave about 6 in. of the wire free, you can then connect the choke directly between components in the receiver. On the other hand you can either gum the test tube cork to the baseboard or, alternatively screw it down and then jam the tube on top of the cork.

Converting Old Condensers

Some enthusiastic constructors instead of buying special short-wave condensers use ordinary .0005-microfarad types, take them to pieces, remove some of the vanes and take up the gap with washers. This then gives a low-capacity condenser which, if it is quiet in operation, will be quite suitable for this one-valver.

You can quite easily graduate to a larger set after you have got the hang of tuning your receiver, and know just how to get the best out of the detector stage.

Remember that no matter how many valves you have before and after it is always the detector valve that governs the efficiency of a short-wave set. Unless your tuning condensers are

quiet in operation, coils correctly wound, reaction smooth, and the set free from hand-capacity effects, you will not be able to bring in very many stations with any degree of reliability.

The next step is to add an amplifier to a one-valver. This will not cause any difficulty because the technique is purely as for broadcast sets. You simply want a low-frequency transformer, another valve holder, a small output valve and grid-bias battery.

This amplifier will enable you to put on the loud-speaker some of the stations that formerly could only be heard on headphones. Fig. 2 shows the wiring.

Circuit for High-Frequency Amplifier

In Fig. 3 you will see a basic circuit for a high-frequency amplifier to add on to the two-valver. You must be careful how you go about this for you come back to short-wave design problems again.

The values are again small, while the tuning coils L_1 and L_2 are of the same values as for the one-valver and should be adjusted in the same way. Notice that there is no high-tension negative connection.

In Fig. 4 you will see how a simple one-valver is connected. The tuning coil consists of three windings with L_1 in the middle, L_2 , the selectivity coil, at the top end of the grid coil, and L_3 at the far end. A 60-volt high-tension battery will be ample, and the valve should be an ordinary metallised detector and absolutely non-microphonic.

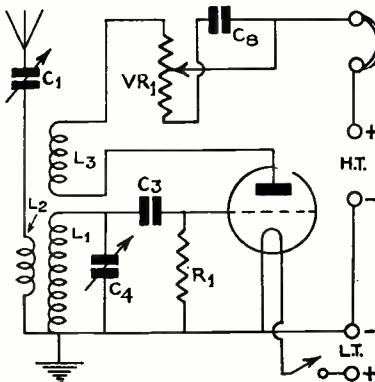
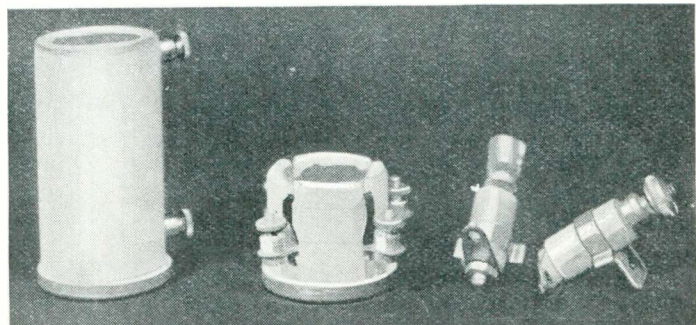

Fig. 5.—A circuit for obtaining reaction on short waves without using a variable condenser

All the components in the five circuits shown have been lettered, and the values kept uniform throughout. C_1 is a variable condenser having a maximum capacity of .0001-microfarad; C_2 is also variable with a capacity of .00025-microfarad; C_3 , the grid condenser, .0005-microfarad; C_4 a .00016-microfarad tuning condenser; C_5 a .006-microfarad fixed condenser across the loud-speaker or headphones; C_6 is a .00002-microfarad variable condenser; C_7 is a .0003-microfarad fixed condenser and C_8 , .1-microfarad. The resistance R_1 can be anything from 3-5 megohms, while VR_1 is 50,000 ohms.

Fig. 5 shows a rather unusual method of obtaining reaction without using a variable condenser. Reaction is obtained by having a coil coupled to the grid coil, with the high tension to the detector valve fed through it. This voltage is made variable.



A set of short-wave formers made of quartz fused at a temperature of 2,000 degrees Centigrade. These are very efficient

CZECHOSLOVAKIA

AS certain districts fed by the Kosice and Bratislava stations have complained that for the bulk of their entertainments they must turn to Germany or Hungary, the Czech authorities have decided to erect a new 30-kilowatt station at Banska-Bystrica.

ESTONIA

With a view to the further development of the broadcasting system, the Estonian authorities have passed a Bill to nationalise the service in the near future. To give adequate reception of the main programmes to listeners they are contemplating the construction of a 40-kilowatt station.



This is the transmitter at Heston Airport, from which you can pick up weather reports throughout the day on 1,202 metres

ON THE CREST OF THE WAVES

Radio News From All Quarters :: By JAY COOTE

FRANCE

The authorities have officially declared that the broadcasts on the long-wave channel by the Eiffel Tower are to be suspended shortly, as this station is causing serious interference to its neighbours. It is expected that the transmissions will cease when the new PTT high-power transmitter is brought into operation. Radio Paris will be responsible for the broadcast of the French National, and PTT of the Regional programmes.

Rennes, of which the 120-kilowatt station at Thourie is to be opened in the spring of 1935, in the meantime has increased its power to 40 kilowatts.

Radio Vitus, Paris, has altered its name, and in its call announces itself as "Poste de l'Île de France."

GERMANY

When the national programmes broadcast by Berlin are relayed by German provincial stations the interval signal is the morse letter "B" (— . . .). To make it of extra utility the tone is that of the normal A;

this permits musicians in the orchestras to tune their instruments.

The Berlin main station has abandoned its musical-box signal, and in its place has reverted to short piano or other musical selections to bridge gaps between programme items.

Work has been started on the new 150-kilowatt transmitter which is to take over the duties of the Deutschlandsender at Königswusterhausen. The site of the station is at Brueck, a small town about one hour's distance by rail from the capital.

In an endeavour to make the broadcasts free from fading effects, the aerial system will consist of seven pylons, each 825 ft. high, set in a circle around the buildings.

GREAT BRITAIN

Air Ministry weather forecasts and bulletins are broadcast daily from Heston Airport (Middlesex) on the new wavelength of 1,202 metres (249.5 kilocycles) at G.M.T. 0845, 0930, and then hourly with the exception of 1330 until 1630, during the winter months.

Although destined to civil avia-

tion, the transmissions are useful to the general public.

NORWAY

Since the launching of the new 20-kilowatt Trondelag (Trondheim) transmitter on the ether, the Norwegian authorities have been concentrating their efforts on an improvement of the broadcasting network. Several new transmitters are in course of construction or planned to be built in 1935. The scheme comprises a 10-kilowatt transmitter for Stavanger to work on a wavelength common to a new relay to be opened at Haugesund, two 20-kilowatts to be installed at Bergen and Kristiansand, and a 5-kilowatt station at Aalesund. The last three plants may be brought into operation next March.

PORTUGAL

Although the National Barcarena station has been on the air some months, the programmes are still of an experimental nature. Sharing as it does a channel (476.9 metres) with Trondheim, which is of greater power, the Lisbon broadcasts are not well heard in the British Isles except after 11 p.m. when the Norwegian studio closes down.

After this hour, Barcarena relays dance music from the Aviz Hotel in the capital.

The only other Portuguese station now operating on medium waves is the CT1GL, a 5-kilowatt at Parede, which operates on the joint Heilsberg - Königsberg medium wavelength of 291 metres.

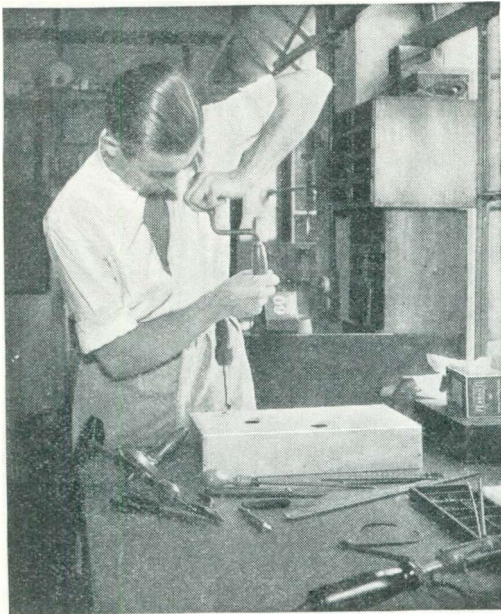

This photograph taken in the "W.M." laboratories brings to light one important point in set building—a clear bench, and a wide and suitable selection of tools

Wireless Jobs Made Easy for Mr. Everyman

By R. W. HALLOWS, M.A.

SPANNERS are, of course, the most useful tools not only for wireless jobs but for heaps of others as well. I have tried at one time or another a good many midget adjustable spanners, but most of them have had pretty bad drawbacks.

Some have jaws made of soft metal; others rapidly wear loose; others again are too thick to be the right things for small jobs.

Hairgrip Spanner

That illustrated in Fig. 1 is one that I have recently added to my own tool kit. It is so well made that it really justifies its name of Hairgrip, for with it you can grip the finest wire tightly.

One of its big advantages is the lock nut, which you can see clearly marked in Fig. 1.

You know how many spanners do not retain their adjustment but work loose as you are using them?

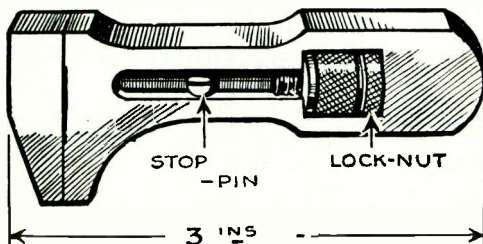

FINE LITTLE SPANNER!

Fig. 1.—A Hairgrip spanner with which it is possible to grip firmly a thin piece of wire. The tool is quite small, being only 3 in. long

When this happens and you put a bit of extra pressure on the nut the spanner slips, with the result that what were once nice sharp corners on the nut become rounded off. A little of this treatment and the nut is round.

With the Hairgrip you adjust the spanner by means of the forward milled nut until it is a tight fit. Then you lock it with the lock nut and it stays put for as long as you want.

Another good point is the stop pin, which prevents you from opening the jaws so widely that the tool comes "from together." You know what happens with some small adjustable spanners: you want to open the jaws just a *leetle* more widely than you ought.

You turn the milled nut, and before you know where you are the thing has come apart and small bits and pieces are rolling about the floor. You cannot do this with the Hairgrip, though you *can* take it apart if you really want to do so by first unscrewing the stop pin.

It's so small—barely three inches in length—that you can keep it in your waistcoat pocket if

you feel so inclined, and there seems to be absolutely nothing to go wrong.

Should you want one of these tools and be unable to obtain it locally I will send you an address where you can get it if you drop me a line, enclosing a stamped addressed envelope.

Tightening Scissors and Shears

One tool that I find indispensable

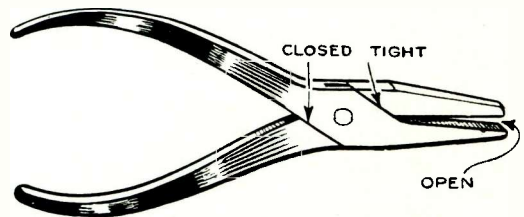

WHAT IS TO BE DONE ABOUT IT?

Fig. 3.—You have often found with cheap scissors that after a while the jaws won't meet. Hints on curing the trouble are given in this article

for wireless jobs is a strongish pair of scissors. These come in handy for all kinds of jobs. With them you can snip flex or plain copper wire, provided that it is not too thick; you can trim off the tags of insulation when you bare the ends of leads; you can cut oiled sleeving or rubber tubing, and you can shape copper or aluminium foil.

Now all scissors have one bad tendency: the screw which holds the blades together works slack in time, and when the blades become loose the scissors won't cut properly.

You take a screwdriver and tighten up the hinge pin. For about five minutes the scissors work beautifully. Then you find that they are pretty well as loose as ever.

There is only one thing to do in the circumstances, and that is to treat the scissors in the way shown in Fig. 2.

Lay them on the jaws of the vice with the head of the screw downwards and the blades pretty well opened. Now take a light rounded or ball-pane hammer and tap the point of the hinge-pin screw gently but firmly until it is riveted over.

You must, of course, tighten the screw well up before you do this, and you needn't *overdo* the riveting. It may be objected that this is a bad

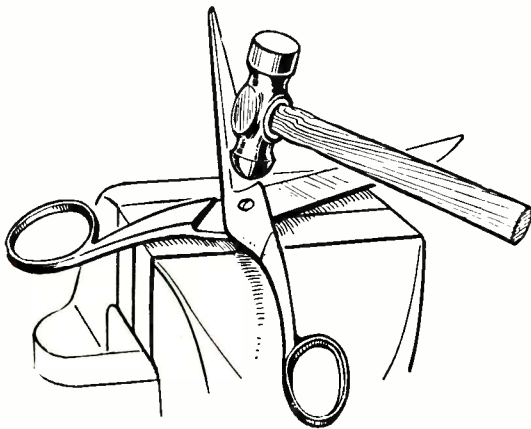

TIGHTENING UP SCISSORS

Fig. 2.—There is no need to send your scissors away to be tightened up. With a little care and a hammer you can easily do the job at home

tip because when the blades want sharpening you cannot now take them apart by removing the screw.

Of course you can! All that you have to do is to file off the point that has been riveted over and the screw will come straight out.

The same simple process can be used for tin shears, and very effective it is.

One Caution

Be careful of one thing when you are riveting the point of the hinge pin. Hold the scissors so that the head of the screw rests firmly on your metal block and be quite sure that your hammer hits the point of the pin and not the blades of the scissors.

If you do hit the blades you may break them, for often they are made of rather hard steel.

In Fig. 3 you see illustrated something that not infrequently happens

to cheap soft pliers —or even occasionally to small ones of good quality if they are strained by being given work that is really beyond their powers.

The illustration shows the trouble in somewhat exaggerated form. The points of the handles seem normal though the jaws are some distance apart. Actually the jaws would probably not be quite as far apart as this, but for all that the pliers

couldn't be of much use in such a state for they couldn't take a firm grip of anything small.

Most people imagine that it is the jaws that are bent, though as a rule it is the handles.

If you get a pair of pliers into this condition leave the jaws alone and bend the handles apart. Go carefully so as not to run the risk of breaking them.

Sometimes, though, the jaws themselves are slightly bent, and then no matter what you do to the handles the jaws won't come together at their tips. If you just close the jaws, lay them on to a block of metal and then use a hammer you will do no good at all: the jaws still remain slightly agape.

Fig. 4 shows a way of dealing with this kind of problem. Put a piece of thin wire or a very fine nail between the jaws as close as possible to their angle. Now lay the pliers on the jaws of your vice or a block of metal, and tap away at the jaws. If you go carefully you will be able to bring them together for quite a considerable part of their length.

I have just been examining a small pair of flat-nosed

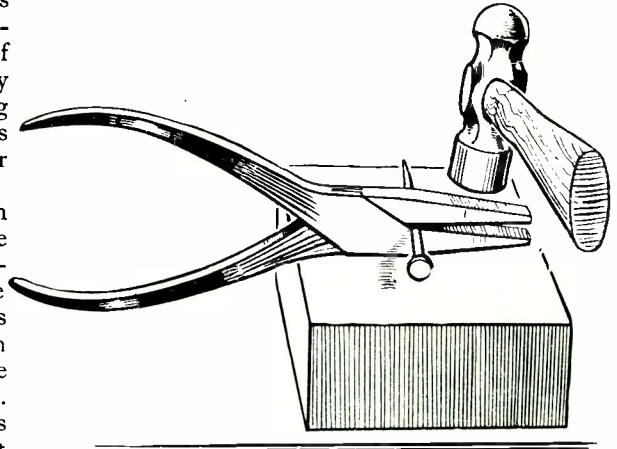

DEALING WITH GAPING PLIER JAWS

Fig. 4. You can easily mend mishaped pliers by treating them in this manner. Note the position of the very thin nail

pliers that I dealt with in this way a little time ago when they were overstrained. The jaws of these are actually just an inch in length, and they now meet perfectly for the last half-inch. When I say perfectly, I mean that they really will hold the finest hair.

The reason why the piece of fine wire or the thin nail is inserted is to provide a fulcrum to work against. By hammering you slightly bend the jaws over it and they do come together.

Novel Component Mounting

Sometimes it pays to mount certain components in a set that you are making not directly on the baseboard but on small upright pieces of wood as illustrated in Fig. 5.

Everyone knows nowadays how

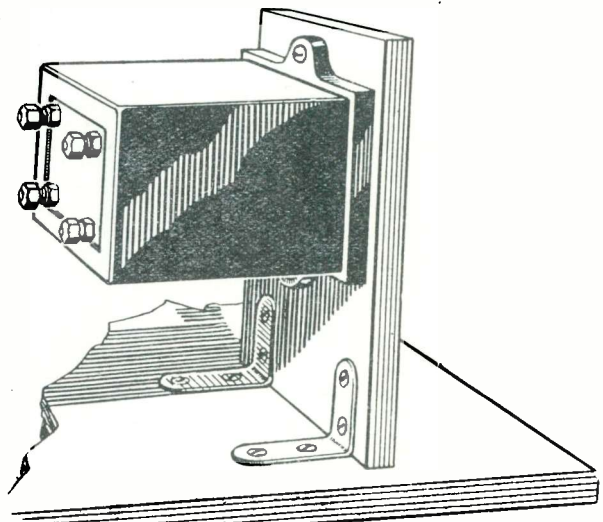

USEFUL METHOD OF COMPONENT MOUNTING
Fig. 5.—This method of mounting transformers or similar components can be useful in a set where space is limited. Incidentally it often ensures short leads

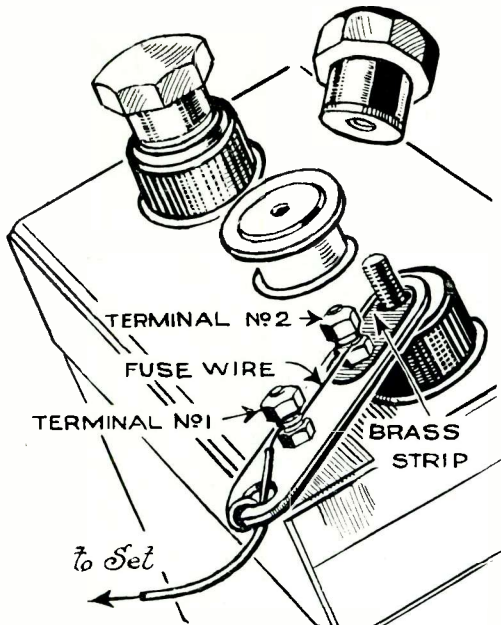

SAFETY FUSE FOR ACCUMULATOR

Fig. 6.—With the aid of a celluloid key tag, a couple of terminals, a small piece of brass and some fuse wire, you can make a handy fuse for your low-tension battery

important it is to keep grid leads, even on the low-frequency side of the set, as short as possible. Now it may happen that owing to the shape of the transformer or the placing of its terminals your leads have to be rather long if you fix this component in the ordinary way flat on to the baseboard.

By lifting it in the manner illustrated on to an upright strip of wood you may contrive to make both grid and plate leads very short indeed.

Useful for Short Waves

This method is useful not for transformers only, but for many other components. In short-wave sets, for example, it is usually good policy to place the variable tuning condensers well back from the panel in order to avoid hand-capacity effects.

Mount them on vertical strips of wood, use extension rods made of insulating material to connect the condenser spindles to the tuning dials, and the job is easy.

Then again there is the question of switches. The wiring of any switch on the high-frequency side should be kept very short. If you put your switch right on to the panel you may have to bring quite long leads to it. But if you mount the switch on to a special little upright of its own well behind the panel your important leads can be only an inch or so in length.

Use a push-pull switch of good quality and extend its operating spindle by means of a piece of ebonite rod. Bring the latter through the panel, fix a knob to it, and there you are!

Another point about the vertical mounting of components in the way suggested is that it often saves valuable baseboard space. By raising a component above the level of the baseboard you can often make room for others beneath it.

Many accumulators meet an untimely end through accidental short-circuits. Large ones of the multiple-plate pattern may survive a brief short almost uninjured, but the mass-plate accumulators, which are now so much

used, are easily knocked to pieces by such treatment.

There is a very simple way of safeguarding your accumulator which I commend to the notice of readers. This is to fit suitable fuses to both of the low-tension battery leads. The average three-valver nowadays requires rather less than .5 ampere of filament current; most super-hets, a little less than 1 ampere.

Hence the accumulator serving a three-valve set may well be provided with a 1-ampere fuse, whilst those designed to carry 2 amperes are

suitable for the super-het's battery.

It is desirable that the fuse should be situated as near the battery as possible. That illustrated in Fig. 6 comes actually between the accumulator terminal and the low-tension lead to the set.

The materials required are a key-ring tag made of erinoid or other non-inflammable material, two small terminals, a little piece of sheet brass or other suitable material, and a supply of appropriate fine wire.

Making the Fuse

A largish hole is first drilled near either end of the tag. One of these is for the flex lead, which is secured by an extra turn round the tag, the other is for the accumulator terminal. The two small terminals are mounted about 1 in. apart on the tag. Beneath one of them is secured a small piece of sheet metal containing a hole for the accumulator terminal.

A pair of these safety fuses can be made in about half an hour; they cost nothing and they may save pounds.

Attach the bared end of the flex lead to terminal No. 1, and between this terminal and No. 2 connect a piece of fuse wire. Slip the free end of the tag over the accumulator terminal and tighten down.

The fuses remain permanently attached to the low-tension leads, and if wire of the right gauge is chosen there is practically no possibility of the accumulator's being damaged by a short.

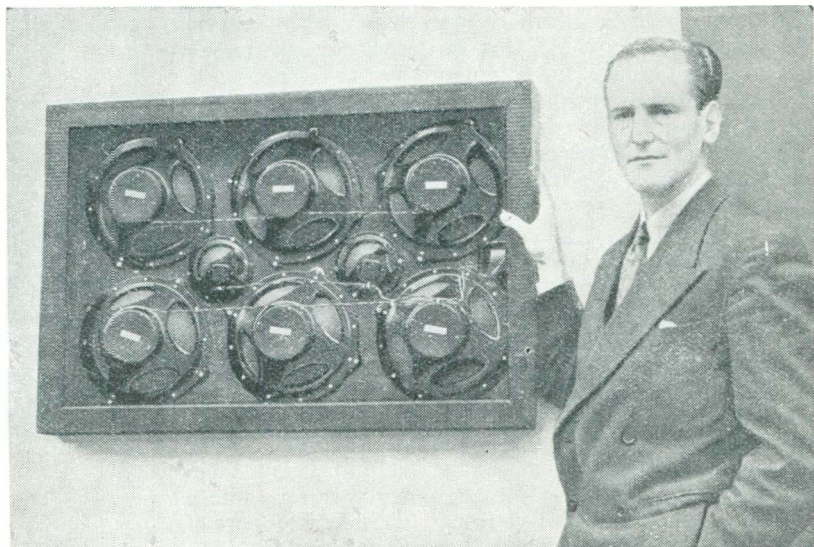

This novel battery of loud-speakers consists of six R95 Rothermel Piezo-electric reproducers and two small "Tweeters," specially designed to give efficient high-note response. A. L. Williams, chief engineer of the Brush Development Co., of Cleveland, who is seen with this novel battery, says that equipment of this kind is being used for public-address work in the United States instead of the usual exponential-horn type

Something New in Detectors!

By Noel Bonavia-Hunt, M.A.



The author suggests that you use a screen-grid valve as a diode detector—something on the lines of this G.E.C. model.

THERE is nothing like experimenting if you want to make progress. One can spend hours trying out various circuits, and one may only do so to learn how not to connect certain wires up: yet, on the other hand, discovery may bless one's efforts.

Experimenting Since 1928

I have been experimenting with detector circuits ever since 1928, and I could write a long story about it. However, I *have* made a discovery, and I am letting you into the secret.

There are three main types of detector employed in wireless sets: they are (1) leaky grid (Fig. 1); (2) anode bend (Fig. 2); and (3) diode. Anode-bend detection is out of fashion and leaky-grid detection is extremely popular. Why? Because it is sensitive to quite weak signals, and this makes it very useful for small sets.

Boosting Signals

Quite a number of people still do without high-frequency amplification and rely on reaction to boost weak signals. If, however, the signal is so weak that there is almost nothing to react upon (as would in

many cases happen if anode-bend detection were used), then a stage of high-frequency is necessary.

But a leaky-grid detector will often provide a sufficiently big signal to enable the reaction to amplify it and pass it on to the low-frequency valve without resorting to high-frequency amplification by means of an extra valve before the detector.

What is wrong with a leaky-grid detector, then?

Well, it must be stated, at the risk of perturbing the minds of some of my readers, that in these days a stage of high-frequency amplification is supremely desirable.

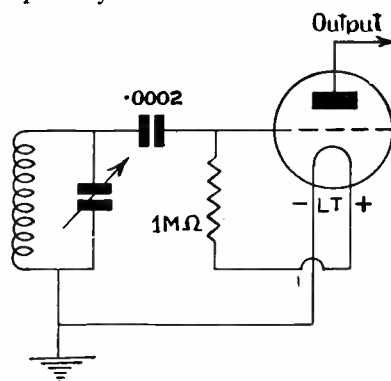

Fig. 1.—The common or garden type of detector arrangement—the leaky-grid method noted for its sensitivity

I have received a letter from a gentleman who lives quite close to Droitwich and, of course, *he* can dispense with high-frequency and get just lovely results from the local! But his case is quite exceptional. And even he would find it precious difficult to tune in Radio Paris or Warsaw, if he wanted to log these stations, unless he had several tuned stages.

Local Conditions

The majority of us are so placed that either we haven't the aerial system we want, or else we cannot get a strong enough signal from more than one station; or again, we get equally strong signals from a number of stations and cannot separate them. There are spots not far from London where it is impossible to tune in Droitwich without a stage of high-frequency amplification, that is, if tolerable quality is wanted.

No Overloading!

If, however, we amplify the signals in this manner, the leaky-grid detector is readily overloaded: in fact, it takes very little to overload it. Those who are out for quality reproduction cannot allow such distortion in this part of the receiver.

We are told that if we want distortionless rectification we must use a diode detector. Of course, the alternative is a power-grid detector. I say *is*, but *used to be* would be a more accurate statement since power-grid detection is out of date.

There are still a number of folk who stick to it, just as quite a number of people stick to other obsolete

reason I am free to use what coupling I like, and that coupling cannot be used unless I have separate valves for rectifying and amplifying.

Apart from all these considerations there is one further difficulty in connection with the diode that confronts us. This is the well-known one that a weak signal is not properly rectified. What the leaky-grid detector will do nobly is to handle just such a weak signal, but the diode will not.

Even if it accepts it, the output is not linear, and therefore one is better off with the old leaky-grid affair. Strong signals are well handled by the diode, in fact, it is hardly possible to overload it.

The snag lies in the reception of signals below a given voltage strength. Either they don't come through at all, or else they come through distorted. So it is quite obvious that the diode fails to offer a solution to our quality seekers, unless they are content to employ two stages of high-frequency amplification; and even then it by no means follows that foreign transmissions will be received with freedom from distortion.

It is because of all these difficulties that I have been on the search for a detector that will handle both weak and strong signals without distortion.

Not only has one to discover the right type of valve for this purpose, but it is also necessary to provide a suitable coupling circuit to the next valve so that the amplified signals may remain undistorted and beautiful quality may be secured.

First of all, I quickly realised the necessity of employing diode rectification, because any other type of detector must inevitably overload on strong signals. Secondly, I had to find out how to make the diode valve really sensitive to weak inputs. Thirdly, distortion on weak inputs had to be avoided.

Well, I found that the only solution of this really tiresome problem lay in the employment of a small 2-volt accumulator costing 4s. 6d.

Since only .1 ampere would be drawn from this very obliging cell, it seemed to me that the idea was not so dreadful after all. Another rather awkward component I found

necessary was a filament rheostat of 30 ohms maximum resistance; not that it is any more inconvenient to use than the very common potentiometer one sees in practically every modern set.

In these days one has almost to apologise for introducing any extra controls beyond the bare minimum in general use. However, the rheostat is essential.

Parts You Need

To battery set owners the rest of the components will offer no difficulty or inconvenience. They consist of a valve holder, a grid-bias battery, and a screen-grid valve. The grid-bias battery will, in all probability, be already in the set; there is no necessity to have more than one in any case, as the same battery can be employed for both detector and low-frequency valves.

Choosing the Valve

As far as the screen-grid valve is concerned, those who do not possess one, or feel that they cannot afford the luxury of another in addition to that already in use in the high-frequency stage of the receiver, may resort to a triode valve instead. It must, however, be made quite clear

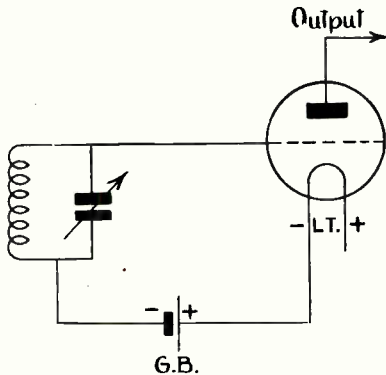

Fig. 2.—Another common form, though not so popular as that shown in Fig. 1—the anode-bend system

fashions, but it is ruled out for battery users, anyway, as it is far too greedy in current consumption.

So we fall back on the diode. And what has made the diode so popular is the introduction of the diode-triode valve, which incorporates both diode detector and triode amplifier in the same vacuum container. There is also the cold metal detector, which many enthusiasts are now using.

Diode-triode Merits

Let us for a moment discuss the merits of the diode-triode. It saves room on the baseboard; it simplifies wiring; it economises current consumption. Three good points right away! Where's the snag? Only two that I can find, but quite enough!

The first disadvantage is the fact that one is tied down to the triode characteristics of the valve, for better or for worse. The second disadvantage is the impossibility of using more than one method of coupling between diode and triode.

To sum up, one is committed to the characteristics offered by the valve maker and there is no choice in the matter.

In my many experiments I have found that I can obtain a much better quality result from a *separate* diode detector coupled to a *separate* low-frequency triode than from the diode-triode combination: and for this

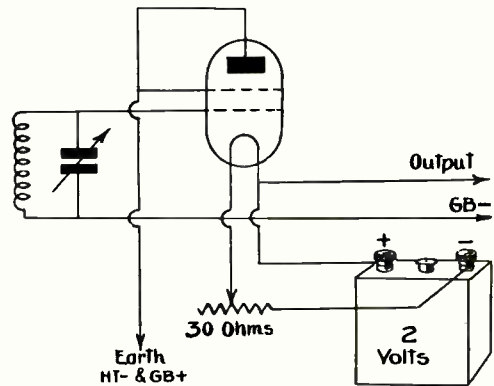

Fig. 3.—A diode as detector in a circuit designed by the author. A screen-grid valve is shown "converted" to the diode

that the best results are obtained from the tetrode.

Now look at Fig. 3. This shows the "diode" detector in its barest form. I use the inverted commas because it is a tetrode converted into a diode (with due apologies to the valve). Of course, there is nothing (except political considerations) to prevent a valve manufacturer turning out a triode on these lines, but at present the spacing of the electrodes in triode design does not favour my diode system so well as the tetrode.

The earthing of the electrode close to the grid makes a difference which no triode can provide. Alternatively, the two grids can be strapped and the anode alone taken to earth, as shown in Fig. 4.

Best Arrangement

The arrangement in Fig. 3 generally works best, but as valves differ slightly from each other both should be tried before a final decision is arrived at.

The filament is heated by a small 2-volt accumulator, the negative of which is taken through the variable resistance, R. This accumulator must not be placed on the high-

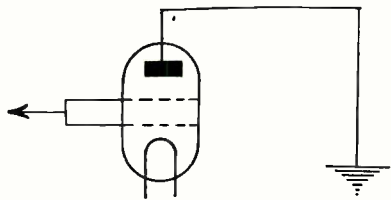

Fig. 4.—An alternative method showing the two grids strapped together and the anode alone taken to earth

frequency side of the valve holder, but on the low-frequency side, or else just behind it or just in front of it.

Supposing the aerial coil, the high-frequency valve and the coupling coils that immediately follow it are placed in the order from left to right, then the accumulator will be placed to the right of all these components and as close to the detector valve as possible.

Accumulator Position

It must not be placed to the left of it. Anywhere but there. The leads from the accumulator must be twisted flex (black and red for choice), and also those from the rheostat. This is shown in Fig. 5.

It must be remembered that high-frequency currents are travelling along these particular leads, and that it is essential to isolate them from the tuned coils.

The best method of coupling the diode to the first low-frequency valve is given in Fig. 6. Note the small .0001-microfarad condenser and the .25-megohm variable resistance, both of which are shunted across the secondary of the

transformer. The latter is connected in auto-transformer fashion, the object being to reduce the impedance of the coupling at high frequencies in the musical scale and thus preserve the upper register.

The bass notes are equally preserved because the D.C. resistance of the transformer secondary winding is over 12,000 ohms, while the inductance is over 250 henries. Those who possess the Ferranti AF4 type of transformer will do well to use it here, this being the ideal for the purpose; but the Ferranti AF8 works excellently in this position.

Now as to the operation of the variable filament resistance. Why should this be needed? Because the sensitivity of the diode is controlled by the actual current applied to its filament. If the signal is weak, only a small current is required; as the signal (or rather the carrier wave) increases in strength, so must the filament heating be increased.

Thus, if we are receiving a powerful local transmission, the full voltage must be applied to the valve from the battery, meaning that the rheostat must be practically short-circuited.

If, on the other hand, we want to tune in North Regional or the Midland Regional (assuming we are in London), or any station which is transmitting at a distance, the rheostat should be adjusted to the optimum position to give the required heat to the filament.

We can only find this point by trial and error: one simply rotates the knob till the point is found, and the station comes in at that point.

The value of the rheostat should not be less than 30 ohms, and this will be found a suitable figure.

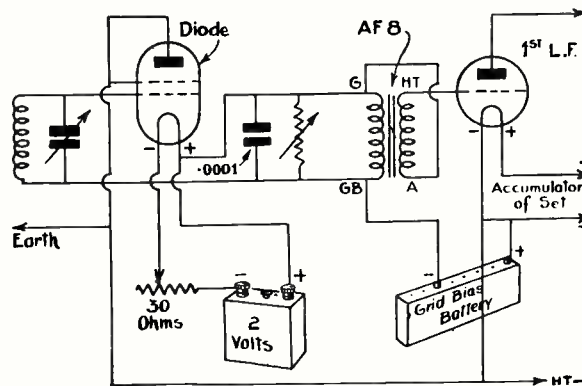

Fig. 6.—Here is the complete circuit for the diode-detector scheme designed by the author, showing the best method of low-frequency coupling

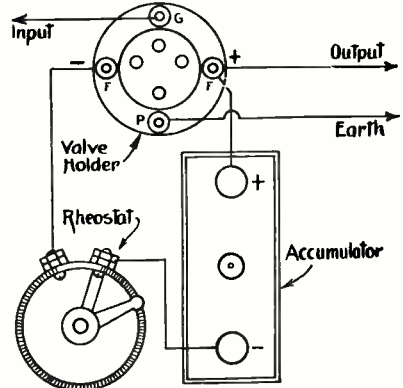

Fig. 5.—How to place the components for the author's novel diode-detector circuit is shown here

This rheostat must be mounted on the panel, and in line with the valve as indicated in Fig. 5.

The 2-volt accumulator need not

What "W.M." Offers

This month we again present our readers with a fine varied issue. "Wireless Magazine" prides itself on the fact that it gives its readers authoritative articles on every radio subject. This fine standard will be maintained and, of course, improved upon as months go by.

Next month's issue will contain another article by P. Wilson on pick-up response curves and Kenneth Jowers will go one step further in his articles on building a short-wave receiver.

This next number will show readers how to add a stage of high-frequency amplification to the battery two-valve described on pages 430 to 433 of this issue.

Tell your friends about "Wireless Magazine"—Britain's Biggest Radio Journal.

Order your January copy early !

be a large one, a 20-ampere-hour type is quite adequate and will last a considerable time before it need be recharged. Possibly it may prove a stumbling-block to some readers, but those who are willing to face the inconvenience (such as it is) will find that it is well worth it.

Really Small Cost

After all, first-class quality has to be paid for, and the cost in this case is very small. If there is no room for the extra cell on the baseboard, it can be placed underneath the set or at the back, provided it is kept away from the high-frequency side. The longer leads, if consisting of twisted flex, should not cause any trouble.



Two members of the "W.M." staff examining the permanent-magnet moving-coil loud-speaker specified for this set. It is small but very efficient

HERE we have pleasure in presenting details of an extremely simple two-valve receiver that is just the thing for the beginner in radio. On test this little set has brought in more than twenty stations on the loud-speaker, proof that it can be relied upon to give a reasonable selection of entertaining programmes under all conditions.

Question of Price

But just as important to many beginners as performance is the question of price—both as regards first cost and maintenance.

Well, we can set your minds at rest at once over both these points. The actual cost of building the set illustrated in these pages—including all the necessary parts, valves, loud-speaker, batteries and wood for building a simple cabinet—does not exceed £4. And as for maintenance, the high-tension current consumption is so moderate that a new battery will not normally be needed more often than once every six months.

Standard Parts

We do not claim anything out of the ordinary for this set; it is built entirely of standard parts that can be obtained without difficulty.

As the valve combination is a simple detector followed by a transformer-coupled pentode there is only one tuning circuit and we had a good

look round for a cheap and efficient coil that would give adequate selectivity under normal conditions.

The coil we eventually chose has been specially designed for the use of those who live within "swamping" range of the new Droitwich station. But one cannot expect everything for nothing and, as is the case with all very simple tuners, selectivity is obtained at some cost in the matter of sensitivity.

No Great Drawback

That is no great drawback, as our tests have proved; there is not much to grumble at in a two-valve that will bring twenty-three stations in on the loud-speaker.

Moreover, this very selective condition, which sacrifices signal strength to some extent, is only used when it is absolutely essential; at

Starting Radio for £4

Here we present full details of a very simple and efficient battery two-valver which can be built for £4—this price including cabinet, valves, batteries and moving-coil loud-speaker. We have had the set specially tested close to a powerful regional station and the log included well over twenty stations

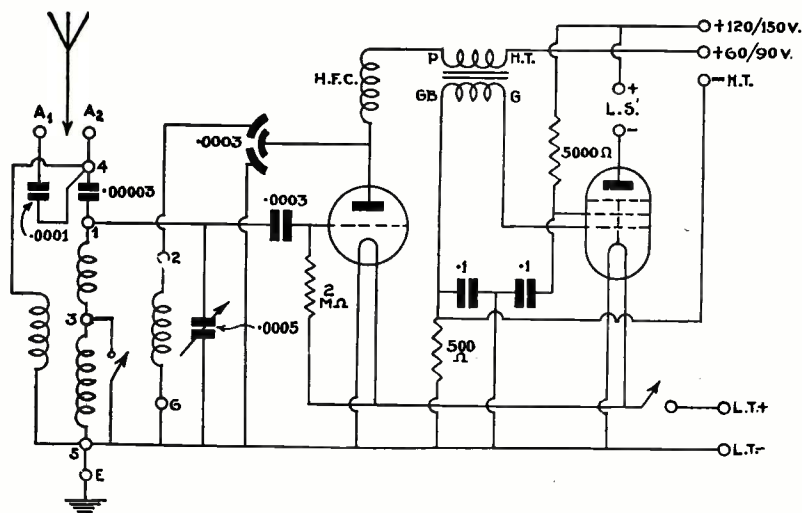

STRAIGHTFORWARD TWO-VALVE ARRANGEMENT

The circuit of the set is perfectly simple—two valves, a detector transformer coupled to a pentode output

other times the selectivity is decreased and the tuner adjusted for maximum sensitivity.

How this is done will be clear from the circuit diagram. It will be seen that the aerial can be connected at two points.

In the first, most selective, condition the aerial is fed through a .00003-microfarad fixed condenser, which forms an integral part of the coil design and is supplied with it, mounted inside the cylindrical former.

Increased Sensitivity

In the second position the aerial is fed through an additional .0001-microfarad condenser; when this connection is used the sensitivity of the set is increased, but at some cost in the matter of selectivity.

The whole success of a design of this type depends on compromise; with these two aerial tapings to choose from, the operator should have no difficulty in adjusting the set to meet the particular conditions that are obtaining at the time.

As the receiver is intended only for operation from batteries and not from a mains unit, it will be noted that no decoupling is

when it comes to searching for distant transmissions.

A high-frequency choke of standard design is used in the anode circuit of the detector valve, but owing to the use of a differential reaction condenser there is no need for a separate by-pass condenser, thus saving expense.

There is nothing out of the ordinary about the transformer coupling between the detector and the pentode; any standard component can be used here. In practice, however, if the set is inclined to be unstable and

resistance in this way only two high-tension positive connections are necessary, thus saving a number of straggling leads. It is for this reason partly that the pentode is supplied with grid bias automatically; there is no need for a separate grid-bias battery.

Constant Quality

Further than this, though, the automatic-bias system has the further advantage that as the high-tension battery falls off in voltage, so is the grid bias automatically reduced, so that the quality (although not the volume) remains substantially unaffected throughout the whole life of the battery.

The pentode output valve actually specified for this set will give an output of the order of 350 milliwatts; in other words, it is capable of operating a loud-speaker at a volume quite sufficient for the ordinary size of living room.

Use of Larger Pentode

If a greater output is required, it can be obtained by substituting a larger type of pentode; but this means that the high-tension current consumption will be increased and that the bias resistance will have to be of a different value—the valve makers should be consulted on this point. Most of these bigger valves will need a 850-ohm resistance.

Before we go any further, though, in our description of this set, let us say that it is our intention to follow it up next month with a three-

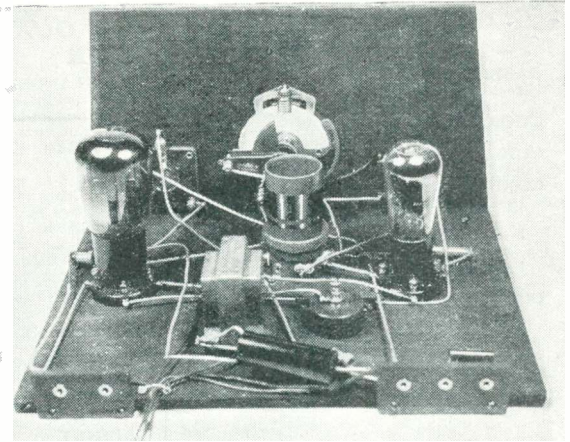

HOW THE SET IS ARRANGED
This photograph shows very clearly the position of every component and valve. The valve on the left is the pentode, the other the detector

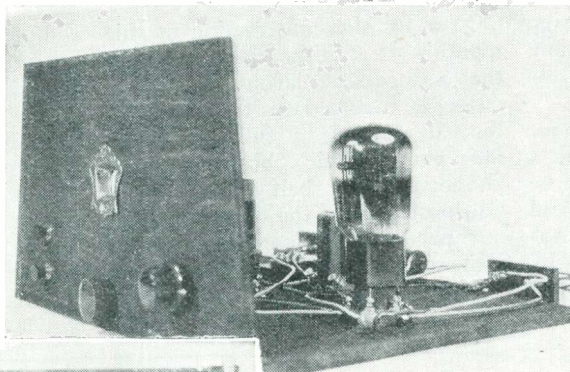

SHOWING THE CONTROLS
On the left of the panel is the on-off switch above the wave-change switch; in the centre is the tuner; and on the right is reaction

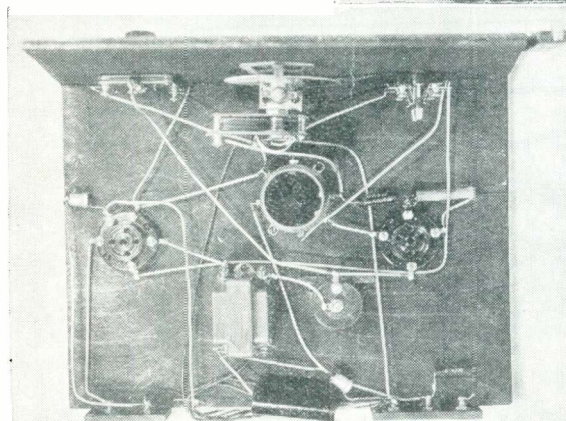

PLAN VIEW OF THE ££ BATTERY TWO
This plan view should be used in conjunction with the third-scale wiring plan which appears on page 432. Set building could not be easier

provided; this is not necessary for batteries and it will be found that the circuit is quite stable in use.

In a two-valver, reaction is a matter of considerable importance, so here we have used the differential method. This gives a very smooth control of feedback and materially increases the usefulness of the set

resistance used for giving automatic bias to the pentode and the other side is used for by-passing the 5,000-ohm resistance used in the screen circuit of the pentode.

This latter resistance is included so that the voltage applied to the pentode screen is less than that applied to its anode. By using a

COMPONENTS NEEDED FOR OUR £4 BATTERY TWO-VALVER

BASEBOARD		RESISTANCES, FIXED	
1—5-ply 12 in. by 9 in. with 3-ply wood panel 12 in. by 7 in. say	1 0	1—Franklin 500-ohm, type ½-watt	6 6
CHOKE, HIGH-FREQUENCY		1—Franklin 5,000-ohm, type ½-watt	6 6
1—Graham Farish, type Snap	2 0	1—Franklin 2-megohm, type ½-watt	6 6
COIL		SUNDRIES	
1—B.T.S. dual-range, Droitwich type	3 6	Ebonite strip 5 in. by 1 in. by 3/16 in.	3 3
CONDENSERS, FIXED		2 doz. ½-in. wood screws, say	4 ½
1—Franklin .0001-microfarad, type tubular	6 6	Connecting wire and sleeving, say	6 6
1—Franklin .0003-microfarad, type tubular	6 6	3 yd. thin flex (Goltone), say	3 3
1—Franklin .1 + .1-microfarad, type tubular	1 6	SWITCHES	
CONDENSERS, VARIABLE		2—Goltone two-point on-off	1 6
1—Ormond .0005-microfarad, type R/503	2 3	TRANSFORMER, LOW-FREQUENCY	
1—Graham Farish .0003-microfarad differential reaction	2 0	1—Graham Farish, ratio 1 to 3.5, type Pip	6 9
DIAL, SLOW-MOTION		ACCESSORIES	
1—Ormond, valve R/361	2 6	BATTERIES	
HOLDERS, VALVE		1—Marconiphone 108-volt, type B496	10 0
1—W.B. 4-pin	6 6	1—Exide 2-volt accumulator, type DTG	4 6
1—W.B. 5-pin	8 8	CABINET	
PLUGS, TERMINALS, ETC.		Wood for home-made cabinet as described, say	3 0
5—Clix metal sockets	5 5	LOUD-SPEAKER	
3—Clix wander plugs, marked: H.T., H.T. + 1, H.T. + 2	4 ½	1—W.B., type Stentorian Baby	£1 2 6
2—Clix spade terminals, marked: L.T., L.T. +	4 4	VALVES	
		1—302 HL2	3 6
		1—302 ME2	10 0

valver. This will contain an extra low-frequency stage coupled by the resistance-capacity method, but all the parts used in the present design will be retained without alteration.

Beginners' Chance

Here, then, is a great chance for the beginner to start radio in a progressive way. This month he can make up the set as described and find out for himself just what a two-valver will do and what are its limitations. Next month he can rebuild the set with the same parts

and add an extra valve—if he finds that a "two" will not give him the results he requires.

Now for the construction of this month's set. In the first place, note that a third-scale layout and wiring guide is included in these pages; but, if desired, a full-size genuine photographic blueprint can be obtained for half price, that is 6d., post paid, if the coupon on the last page of the issue is used by December 31.

Simply address your application to "Wireless Magazine" Blueprint

Dept., 58-61 Fetter Lane, London, E.C.4, and a copy will be sent by return of post.

The advantage of working from a full-size blueprint is that the positions of all the parts on both panel and baseboard can easily be marked through with a sharp-pointed tool if the blueprint is first laid in position over the wood.

Numbered Leads

But whether the full-size blueprint or the reduced-scale drawing shown in these pages is used, when it comes to wiring the set the system of numbered leads should be carefully followed. It will be seen that each connecting wire in the set is numbered separately, the numbers being found in small circles adjacent to the leads. In wiring, the leads should be put in position in the sequence indicated by these numbers; and as each connection is completed, the corresponding number on the wiring guide should be crossed through with a pencil.

In this way it will be impossible to leave any wires out or make a mistake with the connections. A real boon to the beginner—and a system that is also appreciated in the case of bigger and more ambitious sets by the old hand.

Once the set has been completely wired, it can be tried out for the

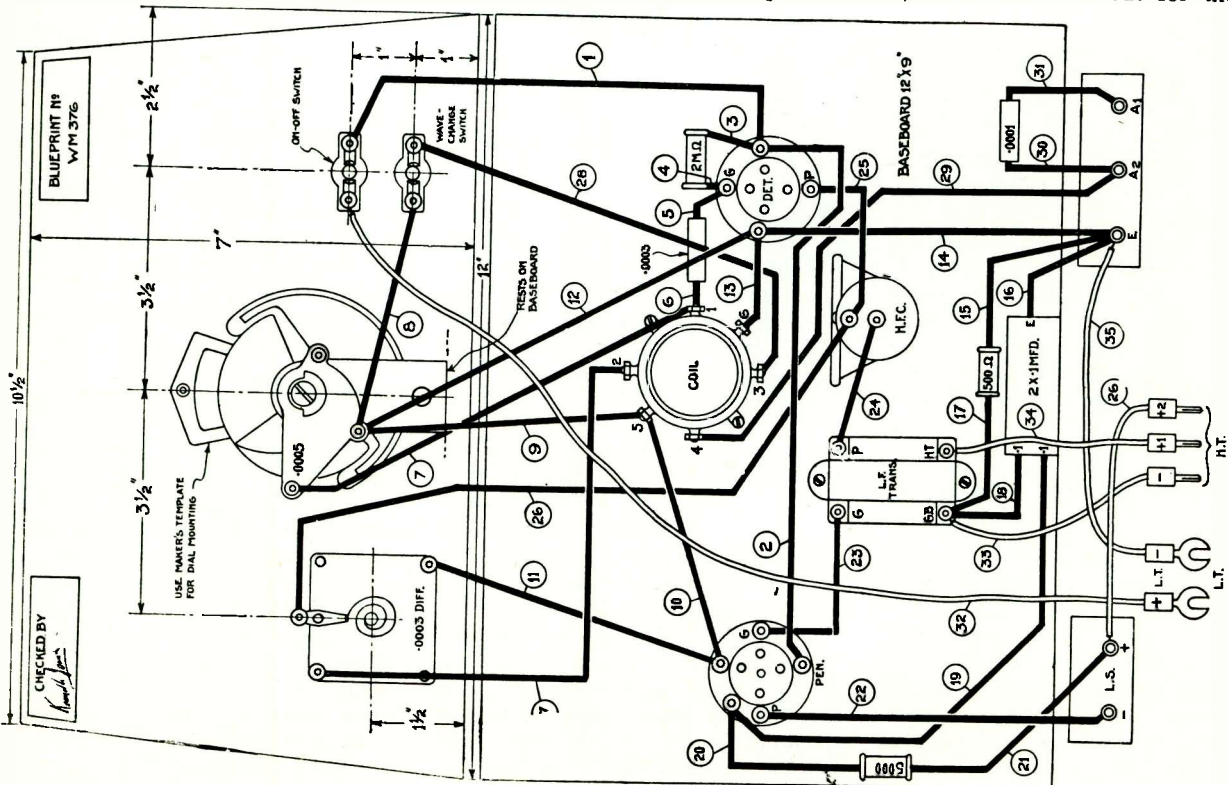

first time. It will be advisable for the beginner to connect up the batteries before inserting the valves in their holders; the battery connections can then be checked before there is any possibility of doing harm to the valves.

Note that only three leads are needed for the high-tension connections, two positive and the third negative.

As there is no output transformer in the set for the loud-speaker, the latter must be of the type with its own built-in transformer. Most modern reproducers are supplied with a tapped transformer so that it can be matched up to the particular output valve in use. In this way, it is not necessary to provide pentode tone correction in the receiver itself.

When it comes to valves, there is great latitude of choice. Any medium-impedance valve will do for the detector stage and any pentode can be used in the output stage. But here, remember, the larger the valve used, the greater will be the running costs, for more high-tension current will be used.

For the preliminary tests, it will be best to put the aerial on to the least selective tapping; that is the extreme right-hand terminal looking from the back of the set. Then pull out the knob of the top switch on the left of the panel; that will switch the valves on.

Reaction Control

Next make sure that the knob of the reaction condenser (on the right of the panel) is turned as far as possible to the left so that reaction is not being used. After that, adjust the wave-change switch to the medium-wave band (by making sure that the knob is pulled out) and then slowly turn the knob of the tuning condenser in the centre.

At some point, you will pick up a powerful station. As soon as that happens, make a note of the dial reading and the name of the station so that you will be able to find your way about the dial without loss of time afterwards. If the station is not quite loud enough, then turn the reaction knob a little to the right; do not go too far, however, or too much reaction will be applied.

WORK FROM A BLUEPRINT!

You can obtain a full-size blueprint of this simple two-valver for 6d., post paid, if the coupon on the last page is sent to the "W.M." Blueprint Dept., 58/61 Fetter Lane, London, E.C.4, by December 31. Ask for No. WM376

Twenty-three Stations on Our £4 Two-valver

TWENTY-THREE stations in the first preliminary test of this two-valver was not bad going, particularly when local conditions were not good. One cannot expect super-het results from a receiver of which the chassis only costs about 29s.

Location for Test

Using an aerial of approximately 75 ft. in length, situated about 15 miles from the local station, selectivity was good enough for me to tune in Brussels No. 2 clear of London Regional, and Berlin between London Regional and Midland Regional. That is about the best possible selectivity one can expect with a receiver of this kind.

During an evening's test, I was able to tune in quite a number of stations not included in my log, which faded or were unidentified. The twenty-three stations logged were those of entertainment value.

Simple Tuning

Tuning, I found, is simplicity itself. All I had to do was to keep the reaction as far advanced as possible, adjust the tuning condenser between zero and maximum and reduce the reaction when volume was too great or quality suffered.

When the receiver was operated in this way, station after station came in at varying strength. Of

course, those stations which were close to the locals in wavelength were not so strong for I had to use the extreme selectivity tapping, but I found that by tuning in stations well below the National or above the Midland Regional, I could get very good volume.

On the long waves, medium-wave break-through was noticed up to 1,200 metres, but this was not sufficient to prevent my tuning in Luxembourg very satisfactorily.

Radio Paris Clear

Radio Paris was free from interference, as was Huizen, but this latter station was not too strong.

I should imagine that those who are living in the swamp area of Droitwich will not have any difficulty in cutting the station out, for when I used the high-selectivity tapping, Droitwich could be cut out as easily as Radio Paris.

A point that interested me was the low running costs. The anode current was approximately 8 milliamperes using a 108-volt high-tension battery.

Big Output

I tried the effect of using a large pentode valve, as suggested, and I was able to get an output of nearly 1,000 milliwatts, but the total anode current went up to 17 milliamperes. K. J.

List of Stations Heard

Station	Dial Reading	Station	Dial Reading
LONG WAVES			
Hilversum 155	Rome 136
Radio Paris 140	Munich 133
Droitwich 118	Midland Regional 128
Luxembourg 50	Berlin 120
MEDIUM WAVES			
Athlone 169	London Regional 110
Stuttgart 156	Brussels 96
Brussels No. I 149	Poste Parisien 90
Prague 144	West Regional 83
North Regional 142	Hilversum 80
Stockholm 138	Madrid 70
		London National 50
		Trieste 36
		F'camp 12

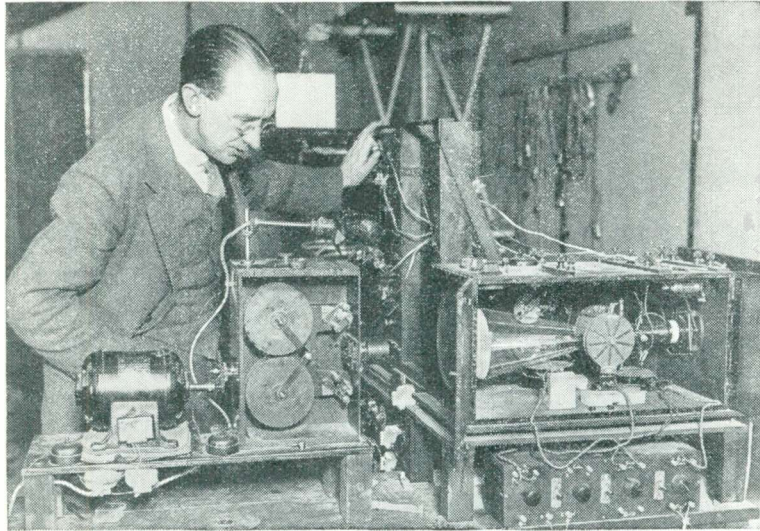

Photopress photo

This complicated-looking apparatus is part of the gear used at the Radio Research station at Slough, where the cause of atmospherics is being investigated. This photograph shows the cathode-ray direction-finder

our wireless waves, they are not definitely *tuned* to any particular wavelength. What is much worse, they contain energy spread over a *very great range* of wavelengths, so that receivers tuned to different wavelengths may pick up some of the energy corresponding to the particular wavelengths to which they are tuned.

Fortunately, the energy is not equally spread amongst all the range of wavelengths in general wireless use. It appears to be worse on the longer wavelengths, a fact which is fairly obvious from even casual

IT is one of the privileges of a wireless expert to get hold of the more abstruse radio questions, just as, in other walks of life, counsel's opinion is sought, especially when it is known that the case is pretty groggy.

A query, which can be summed up under the title of this article, reaches me from a listener in Scotland, through a mutual friend visiting in the South. The listener, who uses his set (a good one, by the way) quite a great deal, complains of trouble from atmospherics.

In Scotland

Naturally, being in London, I cannot judge from practical experience whether he is getting them unduly or not, but from what I know of his particular part of the district I see no reason whatever why he should.

This brings me immediately to a most important point in answering such a query. Are all "atmospherics" natural ones, or are most of them "man-made" atmospherics, created by electrical machinery joined to the mains, especially fairly near to the listener?

Types Confused

Despite the knowledge on this subject, which is now fairly widespread, it is surprising to find how frequently they are confused.

Not so long ago a friend in another part of the same district complained to me (by post) of dreadful "atmospherics," as he called them, which I promptly diagnosed as the noise of tramcars.

Is There a Cure

G. S. SCOTT Explains the Sources of

But this does not apply to the first listener I mentioned, although it does not rule out the possibility of some other source of noise arising from the mains.

First, then, it is necessary to draw a definite distinction between natural atmospherics and man-made electrical noises.

As regards natural atmospherics it must be said immediately that there is no real method of cure. And this is not surprising when we think what atmospherics are! So far as our present knowledge goes, atmospherics are naturally produced electrical discharges of very great intensity, associated either with definite thunderstorms or with thundery conditions.

The most familiar discharge is, of course, the well-known lightning flash, but there may be other types of discharge not yet detectable as lightning. Every lightning flash, however, does definitely produce an atmospheric, and every thunderstorm centre is therefore a prolific source of atmospherics.

These discharges set up ether waves, exactly the same as our ordinary wireless waves, with the important distinction that, unlike

listening on the 250- to 500-metre range and the 1,000- to 2,000-metre broadcasting ranges respectively.

It is worse on the still longer wavelengths—over 2,000 metres—used for many purposes of commercial wireless communication—which may be some small comfort to the domestic listener.

Now the really important thing in wireless reception is not merely the *strength* of the signal we receive, but its freedom from any form of interference, and atmospherics undoubtedly constitute a source of interference which wireless engineers usually sum up as "noise."

After all, wireless amplifiers can now be made very sensitive indeed, so that a merely weak signal can be made as strong as we like provided it is free from noise. If it is not, we amplify the noise as well.

Signal-noise Ratio

The most important thing, then, for clear and enjoyable reception is to get the best possible ratio we can of signal to noise. For example, I can, in the London district, easily get the same programme from the London transmitter and from the Scottish transmitter. When listening

to the London transmitter, my received signal is strong because of the short distance; the receiver is used in an insensitive state (that is, the volume control does not need to be high), and the ratio of *signal to noise* is good.

Strength of Atmospherics

Receiving the same programme from Scotland, the signal is naturally weak. To get it up to the same strength as London I have to use the receiver in a much more sensitive state (that is, with a much higher position of volume control). The result is that all atmospherics which were formerly weak compared with the London signal are now also increased in strength, and the ratio of signal to noise is much worse.

That is, very simply, why atmo-

spherics of much more distant origin give a strength much more comparable to our signal, so that the general number of interfering clicks is much greater—that is, the ratio of signal to noise is much worse.

Until quite recently this has been noticeable in most districts in the difference of atmospheric-interference level as **between** the nearest medium-wave transmitter and the Daventry National transmitter on 1,500 metres.

In districts which are served practically entirely by the long-wave National station this is very important; and a most important point in their case is that the new Droitwich transmitter is a good deal more powerful and will give a much better ratio of signal to noise. And once again, let me say that this is the only thing that really matters.

The present technique of wireless is directed to getting the best possible ratio of signal to noise.

One method which may give slight mitigation (but not a cure) is to have the receiver very selective and very sharply tuned. But this is necessarily accompanied—for reasons which cannot be detailed in this article—by a definite sacrifice of quality, and most listeners would decide the cure to be worse than the disease.

Frame Aerial Cure

A frame aerial *may*, at times, help, but only if the signal and the interference are coming from directions at right angles (or nearly so) to each other. And this is so unusual that as a real help we can safely rule it out.

The only general rule for good reception is to do your serious listening on the station which gives you the best ratio of signal to noise. Generally this is your local medium-wave station, and listeners must be guided by the conditions which they experience in their own district. There is no fixed rule and certainly no general cure.

Work at Slough

It may, however, be of some comfort to listeners to know that the investigation of atmospherics is going on and is considered a matter of high scientific importance. The work on the subject in this country is in the hands of the Radio Research Board, and is carried on at the Radio Research Station of the National Physical Laboratory at Slough.

for Atmospherics?

Electrical Interference and Suggests Remedies

spherics always sound so much worse when listening to distant stations. They are there all the time, but while we are listening to the nearer station the ratio of signal to noise is so good that they do not matter.

Listening to the distant station, whose signal is naturally weak, they become much more important and offensive.

It has already been mentioned above that atmospherics are worse on the long (broadcast) waves (1,000 to 2,000 metres) than on the medium waves of 250 to 500 metres. This again boils down to the matter of signal to noise ratio.

Little on Medium Waves

If we listen to a signal of a certain strength in the 250-500-metre region we usually experience little disturbance from atmospherics, unless thunderstorms are fairly near, say within fifty miles or so.

Even then the disturbance is generally in the form of relatively sparse clicks, unless the centre is very near and unusually active—which does, of course, sometimes happen.

But if we listen to a signal of the same strength in the long-wave region

From the very nature of natural atmospherics, therefore, it will be seen that it is effectively impossible to exclude them from our receiver. The job of the receiver is to receive wireless waves and atmospherics are wireless waves over which, unfortunately, we have at present not one atom of control.

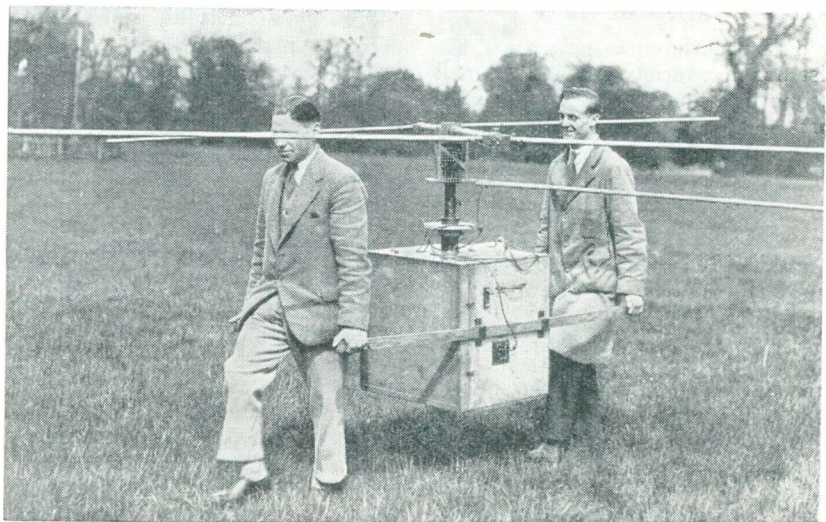

A STRANGE BUT USEFUL PIECE OF APPARATUS ! Photopress photo
This remarkable instrument is a portable short-wave direction-finder, which is used by engineers at the Slough research station in their work on the causes of atmospherics

Work of this kind has now gone on for a number of years, and the Radio Research Station is perhaps the foremost authority in the world on the investigation of atmospherics. A station in Scotland works as the auxiliary observing point with the Slough Station, using special direction-finders by which the place of origin of individual atmospherics can be traced.

It would be impossible if not, indeed, definitely wicked to conclude an article on wireless interference without reference to the other form, mentioned earlier, that is the so-called "man-made atmospherics."

Man-made Atmospherics

Most forms of electrical machinery, even when operating in their normal manner, tend to give rise to interference with nearby radio receivers. The effect of this interference is sometimes clicks, crackling, buzzing, roaring, rumbling, or sizzling noises in the loud-speaker.

Electric motors generally, lifts, vacuum cleaners, electric sewing machines, hair-dryers, fans, and flashing electrical signs are all among possible sources of more objectionable interference.

Garage charging apparatus is another possibility; traffic lights may give rise to frequent clicks; even electric bells are not to be overlooked.

Tramcars are very productive of noise unless the authority takes the necessary steps to silence them, and medical apparatus generally is a particularly active source of trouble.

Variety of Ways

This interference may reach the listener in a variety of ways. A small proportion may be due to direct proximity of the offending apparatus. A small proportion may be carried along the mains and enter the receiver by the mains lead. Mostly, however, the trouble is due to the fact that the offending apparatus sets up high-frequency currents like those of wireless waves.

These currents are carried along the mains and radiated by the house wiring which acts more or less like a transmitting aerial. They are then picked up by the receiving aerial as a form of interfering signal.

The disturbing currents may also be carried a long way by electric wiring systems other than the mains entering the listener's house. That

is why tramcars and trolley buses are such offenders. Their overhead trolley-wires act as excellent carriers and radiators.

Any listener who imagines that he is receiving undue trouble from atmospherics is therefore well advised to make sure that he is not unconsciously suffering from *man-made* and *curable* interference.

It may be somewhat difficult to confirm the suspicion. Usually it can be confirmed by the observed times of occurrence, and this, of itself, often gives a clue which the local Sherlock Holmes can use to track down the criminal.

Frequently it can be inferred from local knowledge, for example, of the nearby presence of any of the sources of trouble already mentioned. Not infrequently, indeed, the listener is his own unconscious criminal, and apparatus in his own house is frequently the unsuspected cause. Try listening to Droitwich the next time the vacuum cleaner is working!

If any doubt still exists, the listener should certainly try to compare his conditions of interference with those of other listeners, say a mile or so away, making sure that the test is effected on the same wavelength range and in generally comparable conditions.

It is also a good thing to compare notes with neighbours not too far away, and generally, indeed, to form an opinion whether your conditions of reception are worse than other people's not too dissimilarly situated and with sets of comparable performance.

This is all helpful, since most forms of interference of this kind can be very greatly mitigated if not indeed completely cured. The interference from electric motors of all sorts can be reduced to quite negligible proportions; flashing signs are troublesome, but can be much reduced.

Tramcars can be made quite inoffensive—so far as electrical interference is concerned—but action in this direction necessarily lies with the tramcar authority, as the silencing devices have to be applied to the car or trolley-bus itself.

Only high-frequency medical apparatus remains a stubborn culprit, and even this is not hopeless, although possibly expensive to cure. The most numerically strong offenders are the many forms of motor and, fortunately, these are easiest

and cheapest of all to silence.

If after taking the steps outlined above, the listener has reasonable suspicion that he is suffering (and I use the word advisedly) from this form of interference, a simple mechanism exists for its investigation.

Complaints of this kind have now reached such dimensions that the Post Office has provided a form for notification and subsequent investigation by its engineers.

This form can be obtained at any Post Office, and any listener who is a victim should have no hesitation or compunction about making complaint. People are now realising this and it has been stated that the Post Office investigates something like 40,000 complaints per year.

Paying for the Cure

All interference of this sort can best be tackled by suppression at the source of the disturbance. As the law at present stands there is no statutory obligation for the user of the offending machine to fit a silencing device, but again the Post Office assures us that justifiable complaints are usually met with extreme goodwill on the part of the owner.

In some cases, additional help can be obtained by the fitting of silencing devices in the listener's premises, but it is just in this respect that the services of the Post Office are so valuable, since they can usually help to locate the interference (if not readily suspected) and to advise all parties concerned as to the best and cheapest method of cure.

Unconscious of Their Sin

This point is worth labouring, since listeners in many places do still put up with avoidable interference, and the offenders are usually quite unconscious of their sin and repentant whenever they are told about it. After all, most of them are listeners themselves.

Like natural atmospherics, interference of this sort is usually worse on the longer waves. Natural atmospherics, however, are much less active in winter than in the summer season, and this may of itself be a valuable clue to listeners who suspect that they are getting more than their share of apparent atmospherics.

A little preliminary investigation by the listener on the lines suggested above is then strongly to be recommended.

All About Pick-up

Response Curves—No. 2

Here we present the second of a new series of articles by P. Wilson, M.A., on pick-ups and their response curves. This month he talks about the various ways and means of showing the frequency response of a pick-up on paper. He gives four entirely different curves showing the frequency response of one pick-up and discusses fully which is the best and fairest curve to use. So that readers can follow the article carefully, the four curves are drawn to the same scale



B.B.C. photo

An intimate photograph of Christopher Stone with his pick-up and records in one of the B.B.C. studios.

Reading Pick-up Response Curves

By P. WILSON, M.A.

IN applied science, curves drawn on squared paper are commonly used to exhibit in a condensed and handy form the relation between two or more quantities.

When there are only two related quantities involved, a single curve suffices, as, for example, a curve which shows the frequency in kilocycles corresponding to any particular wavelength in metres.

If, however, there are three related quantities a series of curves is necessary to show the complete relations. A typical example is that of the characteristics of a valve where the three quantities involved are the grid volts, the plate volts and the plate current.

In most cases our object in drawing the curve is to be able to read off quickly the

value of one of the quantities, given the value of the other(s).

A set of tables would serve the same purpose except that it would have to proceed in jumps, whereas a curve is continuous; intermediate values are therefore more readily determined from a curve.

The main purpose of a response curve is essentially different. Here we are not specially concerned with particular values. Our prime interest is in the general shape of the curve over a range of values.

The distinction is important. In

the first type of curve it does not much matter what sort of scales we use so long as they enable us to read off the values reasonably quickly. In the second case, the scales are vital elements of the picture since they contribute very largely to the visual impression which the curve makes upon us.

It is not merely that the openness or closeness of the scales will bring into prominence or tend to obscure particular features of the curves, though that alone is an important consideration.

Subtle Distortion

A much more subtle distortion of our impressions may be brought about by the type of scale used.

In order to illustrate the fundamental importance of these questions I have drawn a certain pick-up response curve in four different ways.

The appearances of the curves are almost unbelievably different, and yet they represent precisely the same set of facts.

Which scales are the appropriate ones to use will naturally depend on our immediate object. If we are experimenters anxious to discover faults and to correct

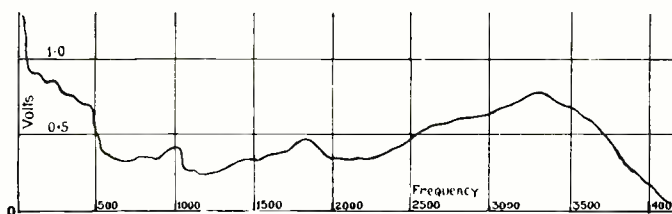

Fig. 1.—Response curve plotted in volts against frequency. Note here that the frequencies between 0 and 4,000 cycles are plotted evenly

them we shall, of course, choose the scales which bring the faults into relief.

If we are salesmen anxious to sell our wares, we may be tempted to use the scales which obscure the faults and persuade the public that our product is as near to perfection (whatever that may be) as they could possibly wish to see.

Bearing Relationship

If our business is that of a technical critic we shall try to do justice to both parties by fixing in advance, if we can, upon scales which bear some relation to what one actually hears.

It will be agreed, I think, that as a rule the third method of approach is the one to adopt. The argument in favour of it is that since we are dealing with sound-reproduction, which cannot hope to be a perfect replica of the original, we can neglect any variation from the standard which is so small as to be inaudible.

This argument unfortunately begs two questions which may prove to be of some importance, namely, what is to be our standard and what do we mean by inaudible? That this is not mere word-spinning may be appreciated from the fact that differences which are not directly audible when dealt with in isolation may yet in combination have a marked effect upon quality.

Most Satisfactory Curve

Still, let us agree that in the first analysis, at all events, the third method is likely to be the most satisfactory.

Happily, we may decide upon one of our scales, the frequency scale, without any misgivings, for it is clear that we actually hear in octaves and not in frequencies.

The octave between middle C on the piano and C₁, the octave below, is appreciated by our ears as precisely the same musical interval as that between C and C₁, the octave above, or, say, between F and F₁.

Our frequency scale must therefore be drawn in such a manner that the interval of an octave, at whatever part of the scale it lies, must always be represented by the same distance.

This means that the frequency scale must be a logarithmic scale. Thus the interval be-

tween 100 and 200 cycles per second represents an octave as does also that between 1,000 and 2,000 cycles per second, and the justification of the logarithmic scale lies in the fact that

$$\begin{aligned} \log x - \log y &= \log x/y, \\ \text{so that} \\ \log 200 - \log 100 &= \log 200/100 \\ &= \log 2 \\ &= \log 2,000 - \log 1,000. \end{aligned}$$

When we come to consider the output scale we are in more doubt. Some people have argued that a pick-up or a microphone is a voltage device and that what we want to know is the voltage output at different frequencies. They would therefore plot the voltages directly.

Others have maintained that what we are concerned with in the end is power output, and since the voltage amplification of our amplifier is, or should be, constant, we ought to translate our voltage input either into terms of power (which varies as the square of the voltage) or into terms of voltage ratio.

Others again have pointed to the fact that we hear in terms of loudness and not directly in terms of power, and they have therefore proposed that the output scale should be in decibels since 1 decibel was at one time thought to be the minimum increase that could be perceived.

Their proposal has the advantage of making the best of both worlds, for a decibel scale can be regarded as a logarithmic scale of either voltage or of power. For the

difference in decibels between two voltages v and v' , corresponding to powers P and P' , may be expressed either as $20 (\log v - \log v')$ or as $10 (\log P - \log P')$.

About the Decibel

Unfortunately for their argument, however, it has recently been demonstrated that the decibel bears no constant relation to the difference in loudness between two sounds. No precise measure of the sensation loudness has yet been discovered.

Ultimately, this means that whatever units we choose to use, our curves will not correspond closely with what we actually hear, except perhaps in the ideal case where the curve is a horizontal straight line; for in that case it would be shown as a horizontal straight line whether our scale is uniform or logarithmic, and whether our unit is voltage or power.

Trusting to Our Ears

It also means that in the last resort we must, for the present, trust to our ears rather than to our measurements, or rather that we must interpret our measurements in terms of what we hear.

This conclusion, unfortunate though it may seem at first sight, is not a reason for despair or for denial of value to response curves. In whatever way we may draw the curves a peak will always appear as a peak at the same place and a trough will always appear as a trough.

Similarly a slope showing a

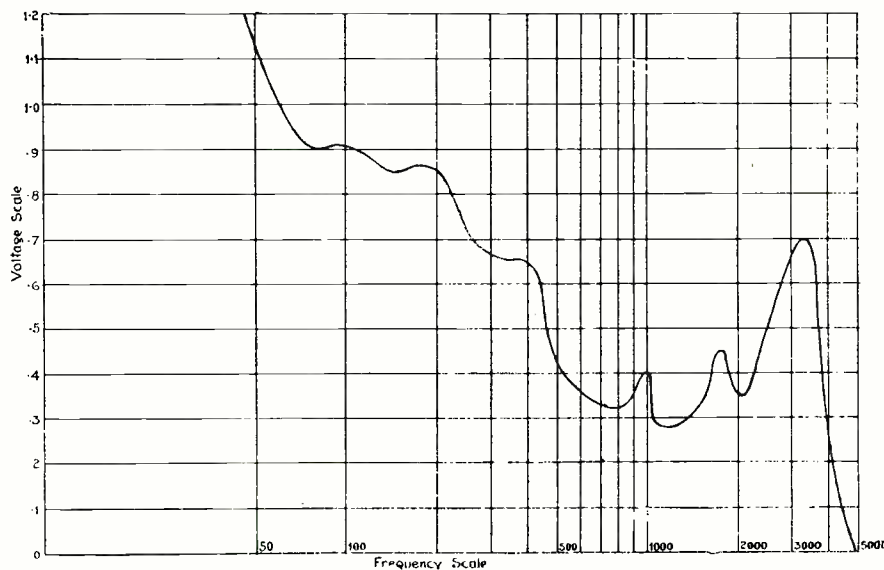

Fig. 2.—Another method of drawing the same response curve, but here greater prominence is given to the voltage changes and the lower frequencies

decreasing response will always appear as such. What we are not justified in asserting on *a priori* grounds is that such and such a peak or trough is negligible.

I have laid stress upon these preliminary points because they are very often ignored or forgotten, with the result that opinions about the goodness or badness of any particular response curve vary a great deal. And that is not the worst.

Divergent Opinions

Just at the moment opinions about the standard response that should be aimed at are divergent.

The story of the changes in my own views in this respect is both typical and significant, so perhaps I may be excused if I become self-explanatory for a moment.

Some ten years ago I held the opinion with most other folk who

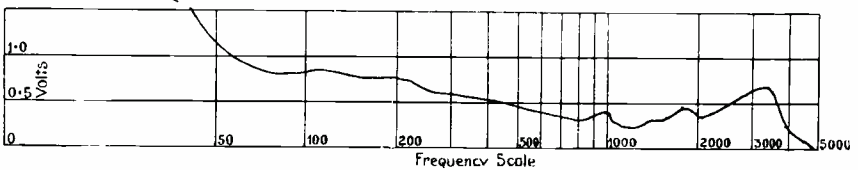

Fig. 3.—The author suggests that this is probably the most satisfactory scale to use. It is a combination of the frequency scale of Fig. 2 and a voltage scale similar to Fig. 1

mistrust this criterion. It did not seem to correspond with what my ears told me was right. I consulted friends of mine who are professional musical critics, and therefore in one sense expert listeners, which, by the way, most musicians are not, and they confirmed my misgivings.

The real trouble was that my observations were somewhat contradictory. One thing only was clear: the difficulties arose at the extremes of the scale, the high notes and the low notes.

A bass response anything

observations were different and seemingly contradictory for radio and for pick-up inputs to the low-frequency amplifier.

Notwithstanding the fact that recording is attenuated in the treble, my ears could not tolerate a uniform response in the treble region. Or, rather, and this re-statement eventually gave me a clue to the reason, my ears could not stand the reproduction from ordinary records by means of a pick-up whose measured response on constant-frequency records was approximately uniform.

I was not surprised in one way that I could stand some high-note boost on radio because I was well aware of the attenuation that takes place in the tuning circuits and in the detector stage.

Not Enough Top

Even so, I was not able to boost as much as I thought should be required.

One very well-informed technical man put it to me at the Show this year: "All this searching after high notes is wrong; what we ought to aim at is a good, clean bass and the treble will take care of itself."

I am sure now that he is wrong.

My present conviction is that it is the *type* of departure from a uniform frequency response that makes all the difference. The fault, dear Brutus, is not in our stars, but in ourselves.

Only during the past few weeks has this conviction become firmly established in my mind.

I have at last achieved a position in which I can increase high notes to the extent of an ascending response in the high treble without aural discomfort. And the massed strings have become more like the original.

Perhaps I should give a hint now, though a full description is outside my present scope, that this achievement has been made possible by attention to the loud-speaker end and in particular to the extension of the treble response and to the suppression of peaks in the middle treble and in the bass.

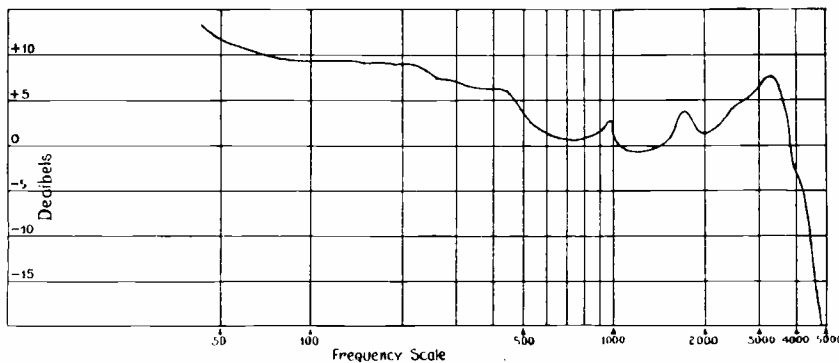

Fig. 4.—The response of the same pick-up plotted in decibels and frequencies. The author does not favour this method

had studied the matter that the ideal response curve for all parts of our apparatus was the horizontal straight line between the limits of audibility, say from 16 cycles to 16,000 cycles; but that peaks and troughs of not more than 2 or 3 decibels did not matter much since a variation to that extent is inaudible save by *direct* comparison.

Length of Range

I believed, therefore, that our object should be to obtain such a flat response over as long a range as possible, and that the goodness of the response would be determined by the length of the range irrespective of what happened outside it.

It was symptomatic of that point of view that manufacturers of apparatus, e.g. transformers, should advertise their products as giving a flat response between such and such frequencies.

Gradually, however, I began to

approaching the amount the uniform response theory demanded was too heavy. On the other hand, if one increased the high treble response the strings were apt to become pinched and wiry, and sometimes very shrill; one never seemed to attain the buzzful quality of massed strings.

A single violin can go shrill in the treble, even to the point of ear-splitting; but the quality of massed strings is quite different: it goes softer and wispier. The strings, as we have been accustomed to hear them in reproduction, have partaken of the quality of an elephantine Stroh-viol.

Tone controls, attenuating treble response, were adopted to mitigate this fault, but though they were successful in producing sounds more acceptable to most people, they were in effect only funking the real issue.

My difficulty at first was that my



In its Osborn cabinet, the Modern Super Senior looks a really attractive outfit, and it brings in the stations, too!

THERE are wireless enthusiasts and wireless listeners. The former class are those who have graduated, maybe from the simple crystal or one-valve battery set to something better; the second are those whose first experience of modern listening has been on an up-to-date super-het.

I graduated to the ranks of a wireless enthusiast through every possible stage, from crystal to valve, from a battery three-valver through subsequent stages till now I am the owner of a six-valve mains set.

Enthusiasm and Pride!

One of my stages in the ladder was the building of the original Super Senior some two or three years ago. I can still remember the enthusiasm and pride with which I showed W. James's latest masterpiece to my friends. They were amazed: so was I!

It was therefore a real pleasure when I was asked to try out this modernised version. Could it be better than the original? Remember I have a mains complex now! Well I fixed the set up on my bench and got to work.

So that you can, to some extent, benefit from my tests, I am going to mention several sidelines about operation and voltages, which I found, to be really frank, rather critical. I am talking about getting the *best* results.

A Test of

Last month we described the modification of Senior, to conform with modern practice. The set A. E. BUTLER, a real enthusiast who has built nearly Full-size blueprints of this set, No. WM375, are

In the first place the most important thing to remember is the voltage applied to the screens of the two high-frequency pentodes. I found that the best results were obtained with about 48 volts. I tried more and I tried less, but this is the figure I finally settled on. With 60 volts the results were about a quarter as good.

Golden Rule of Tuning

The other high-tension voltages are perfectly straightforward, and they are not critical to within ten or so volts.

About the operation, the golden rule to remember, as in fact with all super-hets, is to rotate the tuning dials—especially the oscillator on the right—very slowly. It is no good turning them as if you were tuning a straight set, because if you do, you will miss more than half of the stations.

The two condensers, I found, could be kept fairly well in step; the aerial condenser, however, was about 20 degrees behind the oscillator condenser. Tuning is

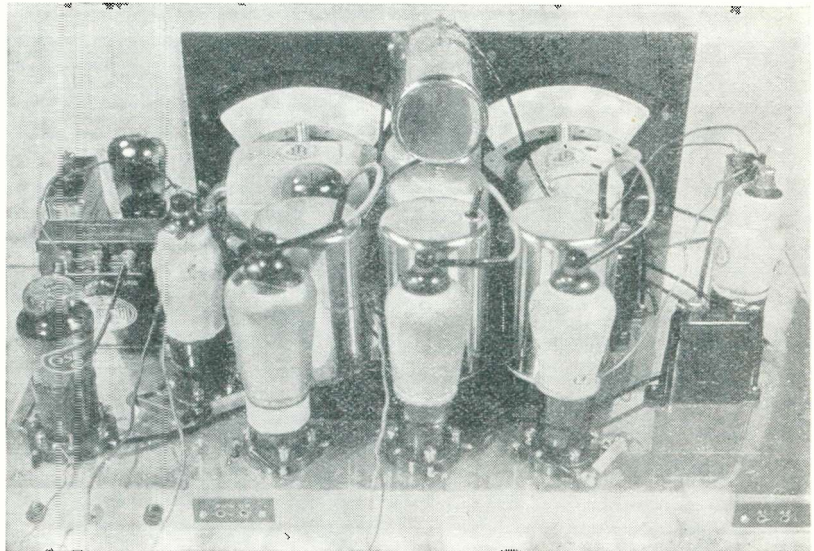

The Modern Super Senior incorporates many of the parts used in the original W. James's design. The set is built on a metal chassis, but there are only a few wires underneath

very easy. All one does in practice is to turn the oscillator condenser degree by degree and then to tune the aerial to bring in the signal at its maximum strength.

Now about the results. It is some time since I scrapped my own Super Senior, but my first impression on being back in the "driver's seat" was the tremendous liveliness of the set.

From London National to Brussels No. 1 there was a station on nearly every degree of the oscillator dial.

the Modern Super Senior

W. James's famous super-het, the Super has been put through its paces by every receiver designed by W. James. available at 1s. 6d. each, post paid

Not all of them would satisfy what are called fastidious musicians, but fifty per cent of them satisfied my idea of quality—remember I am a "bloated" mains user.

There is no use denying the fact that Class B, Q.P.P. or any fancy forms of battery output stage cannot be so powerful as a mains pentode, but it can be just as pleasant to listen to, and in many cases better. Quality here is definitely better than that of any battery super-het I have yet built—that I believe is six.

Forty-three Entertainments

Altogether the total number of entertainment stations on the medium band was forty-three and non-entertaining about the name number. You will find a list of the entertainment signals on this page, so you can tell at a glance the wide selection of programmes that are available.

Outstanding in this list is Berlin on 356 metres. This signal was as good as London Regional, with music more suitable to my tastes than that provided by the B.B.C.!

The local-distance switch on the extreme left of the panel was useful, if not a necessity, on the powerful locals, which are about twelve or so miles away from where the set was tested. You should use this switch when listening to the local—it improves quality.

A. E. BUTLER'S LIST OF STATIONS

LONG WAVES		Station	*Wavelength
Station	*Wavelength		
Kootwijk	1,875	Katowice	396
Moscow	1,724	Midland Regional	391
Radio Paris	1,648	Leipzig	382
Berlin	1,571	Scottish Regional	373
Droitwich	1,500	Milan	369
Luxembourg	1,304	Berlin Funkstunde	356
Kalundborg	1,261	Strasbourg	349
Oslo	1,154	London Regional	342
Heston Airport	1,202	Graz	338
		Hamburg	332
		Toulouse	328
		Brno	325
		Brussels No. 2	322
		Breslau	315
		Poste Parisien	313
		West Regional	307
		Hilversum	301
		North National	296
		Konigsberg	291
		Scottish National	286
		Bari	283
		Madrid	274
		Horby	263
		Turin	263
		London National	261
		Moravska-Ostrava	259
		Frankfurt	251
		Trieste	245

* Wavelength in metres

Wave-ranges covered on the medium band were adequate for my purpose. I could bring in Beromunster comfortably with room to spare at the top, and there was ample room below London National.

On the long waves I heard about fifteen signals. The major ones, such as Droitwich, Radio Paris, Kootwijk, Luxembourg and Kalundborg came in as well as I could expect. I think I can safely say that this battery super will take some beating!

COMPONENTS NEEDED FOR THE MODERN SUPER SENIOR

BASEBOARD	£ s. d.	2—Clix spade terminals marked: LT+, LT—	£ s. d.	TRANSFORMER, INTERMEDIATE-FREQUENCY	£ s. d.
1—Aluminium 20 in. by 12 in. with two aluminium angle strips 20 in. by ¾ in. by ¾ in. ... say	4 6	3—Clix insulated sockets, marked: black(2), red	6	3—Wearite, type OT2	1 2 6
CONDENSERS, FIXED		1—Clix terminal strip, marked: pick-up	6	TRANSFORMER, LOW-FREQUENCY	
9—T.C.C. type tubular valves: .0001-, .0002-, .0005-, .001-(2), .002-, .005, 1-microfarad (2)	9 4	1—Clix terminal strip, marked: A1, A2, E	7	1—Ferranti class-B input, type AF17C	15 0
7—Dubilier, type BB, valves: 1-(3), 1-, 2-microfarad(3)	18 6	RESISTANCES, FIXED		ACCESSORIES	
CONDENSERS, VARIABLE		9—Franklin, type ½-watt: 500-, 1,000-(2), 5,000-, 10,000-, 20,000-, 100,000-ohm, 1-megohm(2) ...	4 6	BATTERIES	
1—J.B. .0005-microfarad, type Nugang with Arcuate drive ...	18 9	RESISTANCE, VARIABLE		1—Anodex 120-volt, type TSA120	1 4 0
1—J.B. .0005-microfarad twin-gang, type Baby Gang with arcuate drive	16 3	1—Erie 1-megohm with switch ...	4 6	2—Ever Ready 4.5 volt grid-bias, type UW6	2 0
COILS		SUNDRIES		1—Exide, 2-volt accumulator, type 1-CZG4	18 0
1—Varley twin unit, coil types BP50, BP51	1 2 0	1—Peto Scott triple coil holder ...	2 9	CABINET	
1—Wearite oscillator, type O2 ...	18 6	Round tinned copper wire, No. 20 gauge, for connecting (Goltone),	9	1—Osborn, type 228 in oak	5 5 0
CHOKE, HIGH FREQUENCY		Oiled sleeving (Goltone) say	1 3	GRAMOPHONE MOTOR	
1—Wearite, type HFPA	4 0	4 yd. thin flex (Goltone) say	4	1—Garrard, type No. 30 with automatic stop and 12 in. turntable	1 10 6
HOLDERS, VALVE		2 ft. screened sleeving (Goltone) say	6	NEEDLE CUPS	
7—Telsen four-pin	3 6	2—Bulgin grid-bias battery clips, type No. 2	9	1—Bulgin Duplex, type NC1	2 0
1—Telsen seven-pin	1 6	5 doz. 6BA ½ in. round head steel bolts and nuts (Adams) say	1 6	PICK-UP	
PANEL		6—Bulgin knobs, types K44(2), K46(4) with one 3/16 in. reducing sleeve	3 5	1—Ediswan Minor	1 1 0
1—Ebonite 14 in. by 7 in.	5 0	SWITCH		VALVES	
PLUGS, TERMINALS, ETC.		1—Bulgin rotary on-off, type S91	1 9	3—Cossor 210SPT I.F.'s and second detector	2 0 6
10—Clix wander plugs, marked GB—1(2), GB—2(2), GB+(2), HT+1, HT+2, HT+3, HT—	1 3			1—Cossor 210VPT H.F. stage	13 6

Curing Car-made Static

IF a radio set is used in a moving car which has not been specially fitted with certain devices known as "suppressors," the programme will be spoilt by a continuous popping noise which rises and falls with the engine revolutions.

This noise is called ignition interference and is generated by the car's ignition system—each time a spark jumps across the plug points it makes a little "pop" in the loud-speaker.

Now, as it is obvious that the car is acting as a sort of low-powered mobile spark transmitter, it seems fairly reasonable to assume that it must be yet another of those infernal forms of apparatus classed as static-producers.

Our Surroundings !

Yet, surrounded as we are with committees, reports, recommendations and imminent legislation, all with a view to abolish static of any kind, no one seems to attack motor vehicles for offending in this respect. So one is forced to the conclusion that they do not offend much after all.

Actually, apart from car radio, where the trouble can easily be eliminated by suppressing it at the source, ignition interference is rarely met with except in short-wave work. According to accepted theory, the radiations generated by a make-and-break apparatus are such that, although they may cause interference at a considerable distance on short waves, they die away too rapidly to affect normal indoor reception on medium and long waves.

Fortunate For Us

It is fortunate for us that this is borne out in practice, otherwise the state of the already static-laden ether, in London, for example, would be chaotic.

However, just as there are exceptions to every rule, cases do sometimes occur of ordinary broadcast receivers suffering from the same unpleasant form of disturbance each time a motor vehicle passes the house.

Interference is only likely to occur when the aerial and/or receiver are

situated exceptionally close to a road. Although this is often the case in busy industrial cities where front gardens are absent, complaints about ignition interference are rare.

Next in importance is the aerial itself. Just as tramway interference is aggravated by the use of an aerial parallel to the wires, and therefore the road, so it is with cars. Even

By R. C. RICKARD

more dangerous in this respect is the lead-in that comes down the front of the house and passes through a front window.

Before dealing with the fairly obvious remedies which can be tried if interference already exists, it should be stated that there is only one guaranteed reliable cure, and that is the totally impracticable one of fitting suppressors to every motor vehicle in the country!

However, the first course to be adopted by the set owner is a thorough overhaul of the aerial and earth system, paying special attention to any possible high-resistance joints, bad earths, or long earth leads. Then, if no appreciable improvement results, the remedy most likely to be effective is an aerial choke.

This is a component which proved its usefulness during the Great War. Magneto-type hand generators were used to supply high-tension for the mobile field-unit transmitters, and these magnetos bid fair to make it impossible for the operator to hear any other signals while sending. So someone hit on the "magneto choke," which happily solved the problem.

It consists of an untuned coil, no more and no less, which is inserted in the aerial lead-in. As its inductance must needs vary according to the aerial circuit used, the best method of trying it out would seem to be a large diameter multi-tapped coil of about 60-75 turns, or better still, one of the old sliding inductances.

In most cases, once the correct tapping has been found, which will be fairly simple if a car can be left

"ticking over" outside the house, the offending noise will be reduced practically to inaudibility.

Occasionally it happens that motor-cars are wrongly blamed for a form of interference which sounds very similar. The deception is quite natural, for the noise only happens when a vehicle passes. Or rather, as patient observation will presently show, when a heavy vehicle passes. Careful investigation will then reveal that somewhere in the house electrical system, or possibly in the receiver itself, is a loose or broken wire which intermittently loses contact.

Obvious Cure

The cure is obvious, but the offending contact may take a lot of finding.

In case a stubborn specimen of car interference is met with which does not yield to simple remedies, here is an experience which, although possibly unique, may well serve as an example of the treatment necessary in severe cases.

A detector-2 L.F. receiver was installed in a house very close to a main road. The aerial was slung between two chimneys and the down-lead taken down the front of the house to the set, which stood close to a front window.

An Appalling Racket !

As a result, almost every petrol-driven vehicle which passed the house caused an appalling racket in the loud-speaker—a most unwelcome accompaniment to a programme. Incidentally, it was noticed that the interference was radiated by both types of ignition—magneto and coil—although one was possibly the worse.

In an attempt to remove, or at least reduce the annoyance, alterations to the aerial and earth system were made without success. Finally, the use of a directional portable proved that the aerial position was practically unimportant.

It was during a detailed examination of the receiver that the grid circuit of the AC/HL detector valve was noticed to be very sensitive to stray induction effects.

Continued on the last page

SEVERAL readers have asked us to test our receivers close to powerful stations, so that they can tell just what would happen if they used such a set in North London, for example.

This month we have done that and tested the five sets in a position where we could see the aerial masts of Brookmans Park. We hope that this will please everybody.

We recently advised a certain reader to buy one of the five-valve super-hets which we had found to be distinctly above the average as regards performance. He wrote back and told us that he didn't like the receiver at all and enumerated a whole list of defects. This reader then had on trial for a week or so seven super-het receivers costing

Tests of the New Sets

By the "W.M." SET SELECTION BUREAU

between ten and eighteen guineas; he turned them all down as being unsatisfactory.

You will realise, as well as we do, that the whole seven could not have been faulty, so we took a personal interest in the matter just to see what was going wrong. Finally we came to the conclusion that this reader was expecting far too much from the receivers and was actually taking the claims of the manufacturers too literally.

For example, one receiver with automatic volume control was rejected because two or three of the fifty odd stations faded. A second was turned down because the visual tuner didn't work on weak stations when it was most wanted. Another, which was supposed to have a very low background noise level, was immediately rejected because the noise level rose between stations. A fourth was not considered simply because the wavelength calibrated tuning dial was slightly out and the set would not



Three American radio stars on a visit to this country spend a few moments with a new Pye set. They seem perfectly satisfied with the results!

bring in all the stations marked on the dial, and so on.

When buying a new receiver you must be a little tolerant. Automatic volume control only prevents from

FREE ADVICE TO PROSPECTIVE SET BUYERS

To make the most of this free advice service, we ask you to answer the following questions:—

(1) The maximum price you wish to pay, and whether you are prepared to exceed this if there is no suitable set at your desired price.

(2) The locality in which the set will be installed.

(3) The stations required, that is, locals only or a selection of foreigners.

(4) Whether you want an entirely self-contained set or one with external aerial and earth.

(5) Whether battery or mains driven. If the latter, whether A.C. or D.C.

A stamped-addressed envelope for our reply is your only expense. Address your inquiry to Set Selection Bureau, "Wireless Magazine," 58-61 Fetter Lane, E.C.4. Tell your friends about this useful service, exclusive to "W.M."

fading the stations which would be of entertainment value. Should they be weak and distant foreigners then nothing will prevent them from fading.

A visual tuner is only really necessary when you are trying to tune in a very powerful station and cannot correctly find the zero point.

When manufacturers claim a low background noise it is usually meant to indicate that when you are tuned to a station there is a low noise level. You must realise that with a set having automatic volume control, unless it is Q.A.V.C., the stage gain must rise between stations, but the noise that you hear automatically drops down to a negligible quantity when the next station is tuned in.

With a tuning dial marked in wavelengths it is almost impossible to have this calibrated so that there is not any discrepancy whatsoever.

The same point applies to a super-het. It has a tuning dial calibrated with about seventy station names. You must not expect to hear *all* of these stations. They are only there for your guidance.

So remember when you are going to buy your new set, do not expect absolute perfection.

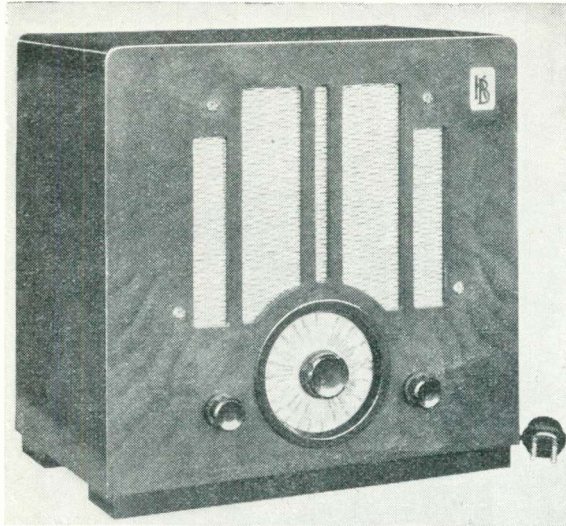

"The tuning scale is rather interesting. It is circular with the station names calibrated all round the edge"

SEVERAL readers have pointed out lately that we have not reviewed any D.C. receivers. We are sorry about that, but there are so few of them and, after all, an A.C./D.C. set is really more useful these days.

The Kolster-Brandes people have just brought out a set which is a real winner as regards price and performance, and we can clearly see that it will be one of the most popular sets of its kind this season.

BRIEF SPECIFICATION

BRAND NAME: K.B.
MODEL: 381
PRICE: £10 10s.

TECHNICAL SPECIFICATION: This is one of the cheapest five-valve super-hets available. It is suitable for A.C. or D.C. mains and is entirely self-contained in an upright table cabinet. The first valve is a pentagrid detector-oscillator (Brimar 15D1), transformer-coupled to an intermediate-frequency amplifier (Brimar 9D2), with a double-diode-triode second detector (Brimar 11D3). This valve is resistance-capacity coupled to an output pentode (Brimar 7D3), while the valve rectifier is of the half-wave type (Brimar 1D5).

POWER SUPPLY: A.C. or D.C. mains, 195 to 255 volts.
MAKERS: Kolster-Brandes, Ltd., Cray Works, Sidcup, Kent.

First of all there are five valves. It is suitable for any mains between 195 and 255 volts, covers all wavelengths between 200 and 600 metres, and 830 to 2,000 metres, while it is the simplest set to handle we have tried for a long while.

Before you begin to criticise any points in this set remember that it only costs ten guineas. For this low cost you get a receiver that has a band-pass filter input, with both capacitative and inductive coupling, feeding into a pentagrid valve.

It is circular with the station names calibrated all round the edge with the English stations marked in green. The whole scale is rotated by the centre tuning control.

On the left-hand side of the cabinet is the combined wave-change switch, giving medium waves to the left and long waves to the right, while the combined on-off and volume control is on the right-hand side. Besides the tuner that is all the controls.

Before we made our official tests we lent it to a member of the "W.M." Staff for his comments. He came back and said: "Jolly good set, and I can receive all the stations calibrated on the tuning dial."

That is good going, for there are between fifty and sixty stations marked and the receiver is by no means an elaborate one.

Our first test was made on D.C. mains, 210 volts, and we were able to obtain an undistorted output of 1,800 milliwatts. The quality was quite good, while sensitivity was much greater than we should have thought possible with a set of this kind.

On 250 volts A.C., the output increased to 2,400 milliwatts, which is more than enough for the average house. The quality was above reproach.

The background noise between stations

K.B. AC/DC Super-het

There is the usual intermediate-frequency stage followed by a diode detector, for rectification and automatic volume control. There are virtually two low-frequency stages, while the output valve, a pentode, gives over 2 watts.

The tuning scale is rather interesting.

was rather on the high side, but immediately the station was correctly tuned the noise dropped to a very low level.

Selectivity on the medium waves was a little better than 9-kilocycles and approximately 10-kilocycles on the long waves. Medium-wave selectivity is particularly good in view of the fact that sensitivity is approximately 20 microvolts per metre. Very few manufacturers can claim a higher average than this.

We were rather of the opinion that small super-hets, although being very good indeed after dark, were inclined to fall off in daylight. During a test one Sunday morning we were astonished to find that we had logged no less than twenty stations, all giving good programmes at loud-speaker volume. Fécamp, Hilversum, Marseilles, Berlin, Hörby, Langenberg, to mention but a few medium-wavers, came through very well indeed.

During an evening test we tuned in Motala, Stockholm, and at least eight or nine other Swedish stations—some of them using very low power—all at very good strength.

We can thoroughly recommend this set as being highly sensitive, selective, and ideal for those who require an inexpensive outfit.

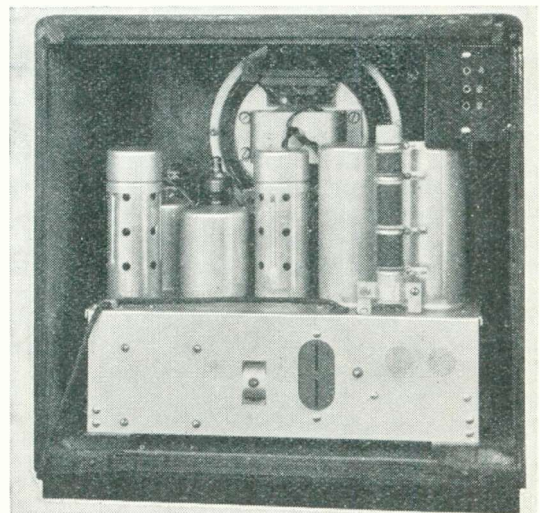

"There are five valves. It is suitable for any mains between 195 and 255 volts . . . it only costs ten guineas"

H.M.V. Fluid-light Autoradiogram

FOR those who require something larger than the model 540 radio gramophone, which we have already reviewed, the Gramophone Company has introduced a five-valve super-het radiogram embodying all of the refinements one now expects to find in a modern receiver of this kind.

The model 570 is actually the Fluid-light Five in radiogram form, complete with an automatic record changer. Anyone interested in automatic record changers cannot help being enthusiastic over the H.M.V. mechanism. It is simplicity itself and you do not need to be a technician to obtain satisfactory results.

All that has to be done is for eight records to be placed on the changer and one large knob set either at 10 in. or 12 in., according to the size of the records you wish to play. You have nothing further to adjust and, as a

many secrets if we tell you that the gramophone pick-up is fed into a double-diode-triode through a specially designed filter and matching circuit. This enables the quality to be of the highest order and you will notice, as we did, that the quality from the gramophone and from the radio are about the same. On some receivers we have tried the quality from the gramophone is sometimes better than the radio or vice-versa.

This receiver embodies the H.M.V. fluid-light tuner. With this in circuit and the volume control

set at zero, you can tune in your stations without hearing a sound from the loud-speaker. This is rather a good idea, because all of the inter-station noises and heterodyne whistles caused by two stations being on the same wavelength, which you are bound to pick up when twiddling the tuning knob, cannot be heard.

All that you have to do to tune in a wanted station is to adjust the pointer on the tuning scale to the wavelength of the station and then make a minute adjustment by means of the visual tuner to take up any discrepancies there might be in calibration. Then turn up the volume control and the station will be heard without any further ado.

The power pack side of the receiver is particularly well smoothed and when the receiver is not tuned to any particular station you cannot hear the slightest trace of hum or background noise.



"The model 570 is actually the Fluid-Light Five in radiogram form, complete with automatic record changer . . . Cabinet work is excellent"

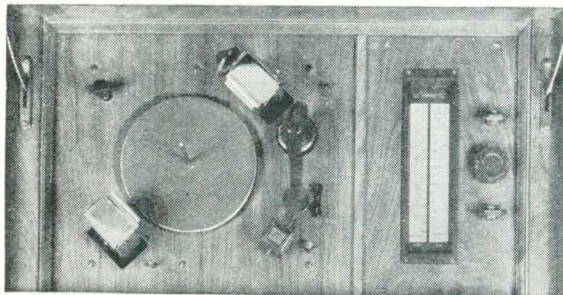

"The controls on the motor-board are conventional and there is no need to explain them as all knobs are clearly marked"

general rule, you can mix records of different makes providing the thickness of the record does not vary too greatly.

From the very broad details given by H.M.V. to the man who buys this receiver, there is nothing to indicate just why the quality from the pick-up should be so good. There are several receivers that use a double-diode-triode detector, followed by a triode output valve, but very few of them give the same standard of quality as does the 570 receiver.

We shall not be giving away too

This receiver was actually tested about six miles from Brookmans Park, where, after dark, we could see the warning lights on top of the aerial masts. Our aerial was quite a good one, about 50 ft. long and, without any attempt at careful tuning, we only lost two stations on either side of the Regional programme.

BRIEF SPECIFICATION

BRAND NAME: H.M.V.

MODEL: 570 AC

PRICE: £34 13s.

TECHNICAL SPECIFICATION: An inexpensive automatic radio gramophone with a heptode detector-oscillator (Marconi MX40), band-pass coupled to a single intermediate-frequency stage (Marconi VMS4B), with a double-diode-triode second detector (Marconi MHD4) transformer coupled to a super-power output valve (Marconi PX4). The fifth valve is a full-wave rectifier (Marconi U12).

POWER SUPPLY: A.C. mains, 200 to 250 volts, 50 to 60 cycles.

MAKERS: The Gramophone Co., Ltd., 98-108 Clerkenwell Road, London, E.C.1

Selectivity was even better on the lower wavelengths and we only lost one station either side of the National programme.

Cabinet work, as usual with H.M.V. sets, is excellent. The controls on the motorboard are conventional and there is no need to explain them as all knobs are clearly marked.

Marconiphone 257 Battery Super-het

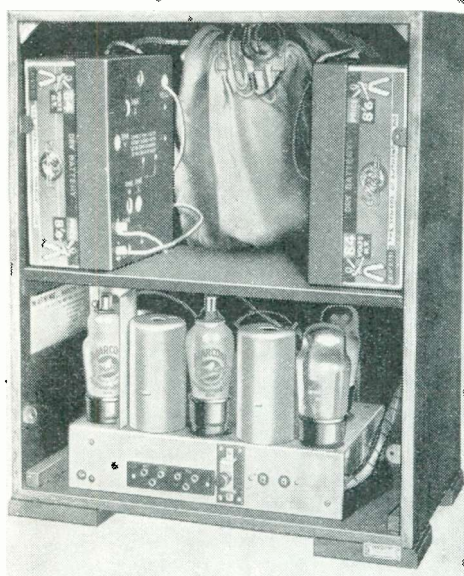

"The entire receiver has been carefully designed and the clean chassis looks most impressive"

WITH the introduction of battery pentagrid valves the battery-set user can possess a four-valve super-het that is comparable in performance with a similar super-het run from the mains. The Marconiphone Company, with their A.C. and D.C. Lucerne Specials this year, created a great stir and a great demand for a battery version of these receivers.

Nothing could be done, however, until a valve was ready which would overcome all the difficulties experienced in connection with a battery super-het. Now that this valve has arrived we have the model 257, a four-valve battery super-het.

This receiver will do almost all that the A.C. version will do. It gives the good quality, ample output for

BRIEF SPECIFICATION

BRAND NAME: Marconiphone.

MODEL: 257.

PRICE: £11 11s.

TECHNICAL SPECIFICATION: A four-valve battery operated super-het with pentagrid frequency changer (Marconi X21), band-pass coupled to an intermediate-frequency amplifier using a variable- μ screen-grid valve (Marconi VS24), followed by a double-diode-triode second detector (Marconi HD21). 1,200 milliwatts are obtainable from the output valve which is of the Q.P.P. type (Marconi QP21). The set is of the table type, self-contained. Price includes batteries and accumulator.

MAKERS: The Marconiphone Company, Ltd., Radio House, Tottenham Court Road, London, W.1.

the average home; it has 9-kilocycle selectivity and is almost free from whistles and background noise.

The set is very compact, entirely self-contained in an oak cabinet with

a dark finish. The loud-speaker is really an outside one, but more about that later. Space has been provided for the high-tension batteries—two of them—and the accumulator.

Of the controls, four are in the front: in the centre is the tuning knob which drives a knife edge along the tuning scale, calibrated in station names and wavelengths. On the medium waves it covers 200 to 560 metres and on the long waves 850 to 2,100 metres—a very good wavelength coverage indeed!

On the left-hand side is the simple volume control while the master switch is on the extreme right.

A novelty is the sensitivity switch just below the tuner. This switch is of the constant push type. You push for "on" and again push for "off." When it is in circuit only the local and more powerful stations are heard, but they are received without mush or interference of any kind.

At the rear of the chassis is a reaction control. This is rather an unusual gadget for a super-het, but it certainly does make the set sensitive. It supplies a small amount of feed-back current which greatly increases the sensitivity of the receiver, particularly in daylight.

Aerial, earth and pick-up sockets are provided. The pick-up is brought into circuit by means of the master switch on the panel, while the common volume control works on both radio and gramophone.

In normal circumstances the anode current is 8 milliamperes for the whole receiver, but this varies accord-

ing to the volume required. With an undistorted output of about 800 milliwatts the current averages about 12 milliamperes. If you want to use an external loud-speaker you will find terminals for your connections on the chassis of the internal loud-speaker.

In almost any locality this receiver will give a good forty programmes at loud-speaker strength. By careful design the number of second-channel whistles has been reduced to a negligible quantity, while mush is not noticeable except on very weak stations.

The maximum output is about 1,200 milliwatts, the quality is very

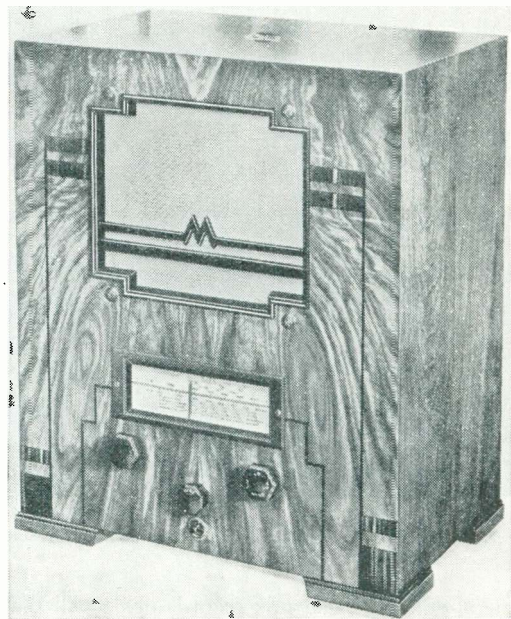

"Is very compact, entirely self-contained in an oak cabinet with a dark finish"

good and the high-tension consumption reasonable.

Selectivity is ample even for those who are close to a local transmitter. The entire receiver has been carefully designed and the clean chassis looks most impressive.

We feel sure that this receiver will be a very popular one for all those who have to use a battery-operated set. This Marconiphone set scores on sensitivity and quality.

Cossor Model 535 A.C. Super-het

THIS 535 A.C. super-het is a receiver which has been designed to give a large number of programmes with quality of the highest order, rather than all the stations on the ether indifferently.

First of all the input circuit to the pentagrid detector-oscillator has been arranged so that it is highly selective and while this wipes out some of the weaker stations, all those stations that can be heard are thoroughly free from interference and will provide really good entertainment.

Another good point is that instead of having the conventional tuning scale, which is usually a mix-up of station names and wavelengths, Cossor has devised a rather ingenious idea which we should like to see more widely used.

Across the bottom of the tuning scale is the normal wavelength calibration and travelling pointer. The calibrations are in wavelengths between 200 and 500 metres on the medium waves and 800 to 1,950 on the long waves. At the top of the scale are a number of station names with the wavelengths against them.

So if, for example, you wish to tune in Droitwich you will see that the wavelength is 1,500 metres, then all you have to do is to adjust the pointer to that wavelength on the tuning scale, and there you are!

To make sure that you are correctly tuned and to allow for any slight discrepancies in calibration, on the left hand side of the escutcheon is a visual tuner of the neon type. All you have to do after you have approximately tuned in your station is to slowly turn the tuning knob until you obtain the maximum brilliancy in the neon bulb.

About the cabinet: it is neat and well worthy of the Cossor tradition for good quality.

We were rather interested to see that the second detector and A.V.C. valve was a double-diode. As you probably know, the diode valve gives the most perfect rectification possible, and there is no possibility of overloading as the diode will handle 200 volts r.m.s. input.

The second diode in the same bulb provides automatic-volume-control voltage, which is applied to the grid circuit of the intermediate-frequency valve and to the pentagrid frequency changer.

Even with the diode detection the input to the low-frequency pentode is sufficient to obtain an output of 3 watts with a very low percentage of second harmonic content. This output is fed into a loud-speaker of the energised type which has been speci-

ally designed to match up with the output stage. A tone correction circuit is fitted to the loud-speaker.

The makers have provided terminals for the aerial and earth connections—rather a good idea! Gramophone pick-up sockets are provided, while provision has been made for external loud-speakers.

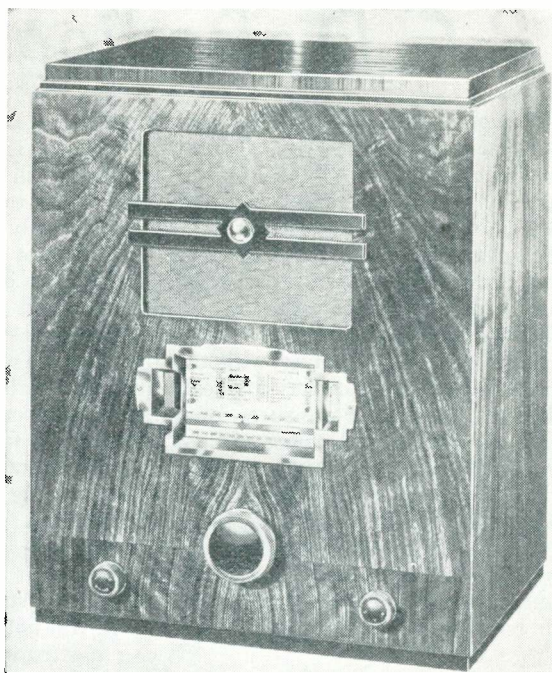

"About the cabinet: it is neat and well worthy of the Cossor tradition for good quality"

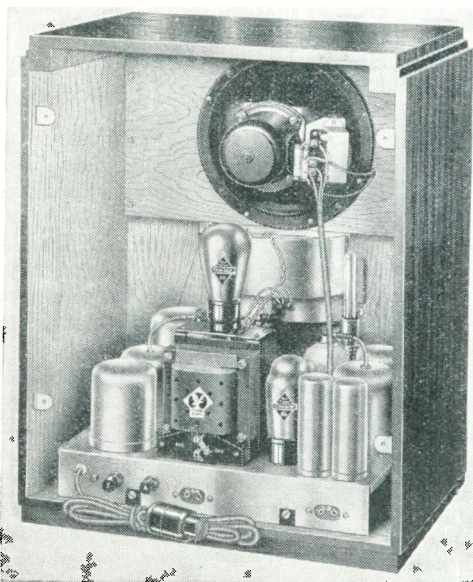

"The makers have provided terminals for the aerial and earth . . . gramophone pick-up sockets are provided . . . provision has been made for external loud-speakers"

BRIEF SPECIFICATION

BRAND NAME: Cossor.

MODEL: 535.

PRICE: £12 12s.

TECHNICAL SPECIFICATION: Five-valve super-het for A.C. mains. It is entirely self-contained in a table type of cabinet. The first valve is a combined detector-oscillator using a pentagrid (Cossor 41MPG), which is band-pass coupled to an intermediate-frequency amplifier (Cossor MVS/Pen). The second detector is a double-diode (Cossor DDA) coupled to a steep-slope power pentode (Cossor 42MP/Pen) with a full-wave valve rectifier (Cossor 442BU).

POWER SUPPLY: A.C. mains, 200 to 250 volts, 40 to 100 cycles.

MAKERS: A. C. Cossor, Ltd., Cossor Works, Highbury Grove, N.5.

On the left of this knob is the volume control, which works in a clockwork fashion, while the on-off, gramophone and wave-change switch is on the right. This is engraved so that there is no need for us to say anything about it. A variable tone corrector protrudes from the loud-speaker fret, so if you do not like the tone you can alter it.

The number of stations that we tuned in was about sixty, of course spread over a period, but during quite a short evening test fifty stations were easily logged.

R.G.D. Radiogram—Model 703

IT is going to be a very difficult matter to tell you of all the virtues of the R.G.D. 703 in the limited space available. This receiver is for the connoisseur, and although the price may at first glance seem heavy the features embodied more than amply make up for it.

The average man, if he were able to build himself a receiver without considering its costs or its technical difficulties, would, we are sure, construct something on the lines of this 703.

The 703 is a seven-valve super-het. There are three signal-frequency tuned circuits, with a separate oscillator and a single intermediate-frequency stage with four band-pass tuned circuits.

The pre-detector high-frequency stage ensures maximum range with complete freedom from interference and second-channel whistles, while automatic volume control being applied to three stages makes quite sure that stations are prevented from fading.

A conventional double-diode-

triode is used as a second detector, but this is resistance-capacity-coupled with a specially compensated circuit to a triode output giving approximately 3 watts.

We cannot praise too highly the cabinet work of this R.G.D. cabinet; it is of solid walnut with the automatic-record-changing equipment in the top. Twin loud-speakers are fitted to a baffle board in the bottom. So soundly constructed is the cabinet that even at full volume there is not the faintest trace of vibration or rattle.

The tuning dials are calibrated in wavelengths. These wavelength markings or calibrations are widely spaced, so it is a simple matter to tune in the station you require.

We will not waste space by telling you how many stations you can hear, for every station with a wavelength of its own can be tuned in, provided the conditions are more or less reasonable. We logged sixty or seventy stations easily with only a loft aerial, while the daylight range was found to be phenomenal.

In common with other R.G.D. receivers, background noise level is very low. Apparently this is a special feature of this type of set.

The frequency response can be varied by means of a special switch controlling the high-frequency circuits. This enables the frequency response to be cut off at 3,000, 4,000 or 7,000 cycles per second. This variable response is very useful, particularly if you want to get the best from your gramophone records.

Talking about gramophones, the automatic record changer will play eight 10-in. or eight 12-in. records without attention and any of the records can be rejected or repeated at will.

One of the new piezo-electric-crystal pick-ups has been fitted which, besides reducing record wear,

gives really remarkable reproduction. The high-note response is particularly fine, while the bass register is crisp and clear.

During our tests we found that the frequency response was almost level between 45 and 6,000 cycles.

The construction of the chassis is typically R.G.D. The six receiving valves are equally spaced along the rear of the chassis and screened by metal compartments. The seventh valve, a 350-volt rectifier, is behind the output triode.

BRIEF SPECIFICATION

BRAND NAME: R.G.D.

MODEL: 703 A.C.

PRICE: £73 10s.

TECHNICAL SPECIFICATION: An automatic radio gramophone with twin loud-speakers in a large handsome cabinet. The first valve is a high-frequency amplifier (Mazda AC/SG/VM), followed by a multi-electrode first detector (Mazda AC/SG/VM), with separate triode oscillator (Osram MHL4). A single intermediate-frequency stage (Mazda AC/SG/VM) feeds into a double-diode-triode second detector (Mazda AC/HL/DD), which is in turn resistance-capacity coupled to a triode output valve (Mazda PP3/250). The set uses a full-wave valve rectifier (Mazda UU120/350).

POWER SUPPLY: A.C. mains, 190 to 250 volts, 40 to 60 cycles.

MAKERS: Radio Gramophone Development Co., Ltd., 17-20 Frederick Street, Birmingham.

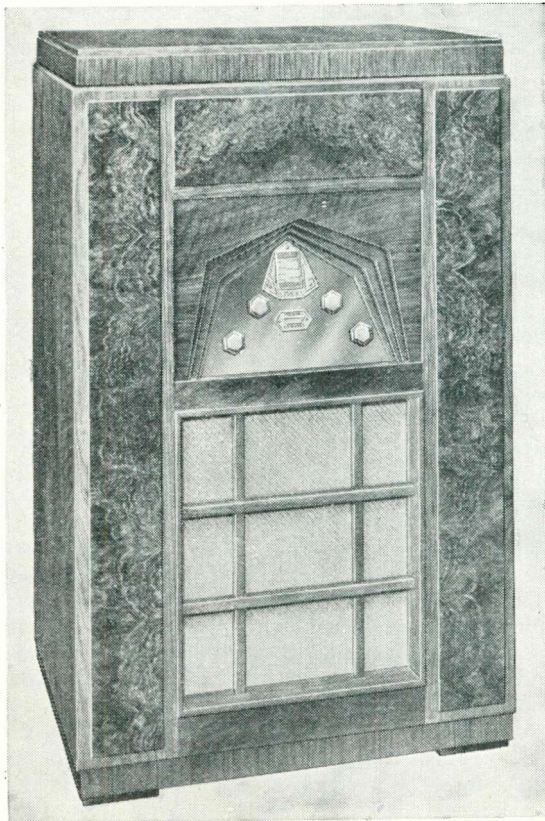

"There is no question that this receiver is a magnificent instrument in a class of its own"

The voltage adjustment for the transformer primary, by the way, is quite a simple matter as the terminal strip is actually on the transformer casing behind the valve rectifier. The aerial and earth terminals are clearly marked while the internal loud-speakers can be cut out of circuit by simply removing two plugs.

A visual tuner of the needle type which, incidentally, is dead beat in action, makes tuning remarkably simple.

It is very useful if you are listening to stations with a high-pitched whistle in the background to be able to alter the top-note cut-off and to increase the selectivity at the same time so as to cut the whistle right out.

Instead of having just the conventional tone-controlled circuit, R.G.D. has combined this control with the selectivity control.

The idea of this is that when you increase the selectivity you also increase the frequency response and vice versa.

There is no question that this receiver is a magnificent instrument in a class of its own.

This is a Super-het Season!

J. H. REYNER, B.Sc., A.M.I.E.E.

Analyses the Season's
Developments and Forecasts
Future Progress



Not only is this a super-het season, but it is a season of big super-hets. Even the ladies find the works of a big super, such as this nine-valve H.M.V. chassis, fascinating

A WELL-KNOWN American radio manufacturer said recently that when he wanted to know which way to move he made an analysis of the developments over a series of years and in this he found presented a sufficiently coherent story for him to see the next step. American radio must be a more logical business than over here—in fact, I feel sure it is—but it is nevertheless interesting to analyse the developments of this season and try to obtain some picture of future progress.

Of Considerable Interest

In the last issue of "Wireless Magazine" there was a summary of the season's receivers which many readers must have found of considerable interest. I have been analysing the material on which this summary was made, particularly with reference to some of the more technical details which could not be included owing to considerations of space and simplicity.

The point which strikes one immediately is that this is emphatically a super-het season. Some 60 per cent of the total receivers are super-hets. Next in order of

popularity comes the familiar three-valve H.F.-detector-L.F. set with slightly more than 20 per cent.

Sets with more than one high-frequency stage are very much in the minority, being about as numerous as straight detector sets with no H.F. at all, each of these classes accounting for a little under 10 per cent of the total.

This considerable swing-over to super-hets was to be expected. "Wireless Magazine" actually started the super-het craze three years ago with the Super 60, and the great improvement in selectivity which could be obtained over the existing methods at that time caused a real sensation.

Gradually super-hets have made their way into the manufacturers' programmes, and nowadays a good crop of stations with reasonable selectivity can be obtained on the average super. Its simplicity of operation makes it appeal to the user, and the circuit is deservedly popular.

Whether it really does meet the requirements of the user is another matter. A manager of one of the largest manufacturing firms in this country has often said to me:

"Personally I wouldn't give two-pence for any of them. The simple three-valve receiver satisfies my needs very much better."

In practice, of course, the power of the modern super-het brings in interference, mush and whistles, and the quality leaves a good deal to be desired. The popularity of the three-valve set, although it is a bad second to the super, shows that many people share this opinion.

Super-het Oscillators

However, let us look at the circuits more closely and see what the manufacturers are doing. Out of the total number of super-hets, we find that some 14 per cent are provided with a separate oscillator, all the rest using a combined oscillator-detector. The pentagrid or octode accounts for the slightly greater proportion of these combined arrangements, the remainder being triode-pentode or tetrode circuits.

Personally, I always regard the triode-pentode as nothing but a separate oscillator, and I do not think it should be included in the list of combined oscillator-detectors. The inclusion of the two valves in the one bulb has no electrical effect

on their performance whatever. Tetrodes or pentodes as frequency changers are in a very small minority, so that we can say that the frequency-changing stage of the super-het has really received considerable attention, and this I think marks the fundamental step forward in design this season.

Harmonics Can Be Avoided

By paying due attention to this very important point harmonics in the oscillator can be avoided, thereby minimising whistles, a good conversion conductance can be obtained which tends to reduce noise and, finally, even sensitivity can be produced over the whole of the waveband.

This latter point is particularly noticeable in some of the modern super-hets which I have handled. The pentagrid in particular gives a very uniform sensitivity despite the inevitable variation of circuit efficiency and oscillator voltage as one rotates the tuning condenser.

Second-rate

Some of the older super-hets, or even some of this season's models which are really not up-to-date in design, are very second-rate in this respect.

Thirty per cent of the super-hets were provided with a pre-high-frequency stage. The customary practice in this country, of course, is to use a two-circuit aerial tuner in order to avoid second-channel interference. This being so, the cost of using a high-frequency stage in preference to a band-pass filter is relatively small, and the gain in performance, more particularly in the ratio of signal to noise, is very great.

So much is this the case that one manufacturer has had the courage to leave out his intermediate-frequency valve altogether, so that his sequence consists of high-frequency stage, frequency changer, second detector, and output stage. Yet the set has a performance at least as good as the conventional arrangement with added advantage of a

much better signal-noise ratio.

The battery user is very poorly catered for in the super-het field, the proportion of mains sets to battery ones being about five to one. Affairs are rather better with the simpler types of sets, and in the three-valve category, for example, the proportions are approximately even.

If one analyses the whole set field, the proportions are as follows :

A.C.	40 per cent.
Battery	37 per cent
A.C./D.C.	16 per cent.
D.C.	7 per cent.

From these figures it would seem that the battery user was well catered for, but it is only in the simpler and less used types of set. For instance, an appreciable proportion of the battery sets are portables and transportables, which are nothing like as popular as they were. In fact, portables comprise only some 4½ per cent of the total number of sets.

Then again, the greater proportion of the sets having no high-frequency stages at all—the simple detector-2 L.F. type—are battery sets, so that the battery user who really wants good performance is rather at a disadvantage.

This is no doubt due to the difficulty of maintaining a small high-tension consumption with a large number of valves (and from the battery user's point of view we must consider even four valves large). It seems to me that a market is being neglected here. There are tens of thousands of users who already have detector-2 L.F. or H.F.-detector-L.F. sets.

It seems doubtful, to say the least of it, whether they will be persuaded to change their sets for another of the same type. One manufacturer, however, has spent considerable research on developing really good high-frequency circuits for his simpler receivers, and I am told that he is reaping a rich reward.

A.V.C. Craze

The rise to popularity of the super-het has brought with it the A.V.C. craze. Practically all super-hets are fitted with automatic volume control, and they nearly all obtain it by the use of diodes. Hence we find a very considerable increase in the use of diode detectors, either in the form of separate double-diode valves or as combination valves such as double-diode-triodes.

In fact, 50 per cent of the detectors used in this year's sets are of the double-diode variety. They are almost exclusively used in super-hets because reaction is difficult with a diode detector and few sets are made today, other than super-hets, capable of dispensing with reaction.

Streets Ahead of the Triode

Of the remaining detectors the majority are triodes, but a few firms still employ tetrodes or high-frequency pentodes. The proportions are about two to one in favour of the triode. Price is probably a consideration here, because on technical terms the screened valve is streets ahead of the triode. It gives a better amplification, a better response curve, and a very much better selectivity, its principal difficulty being that of obtaining reaction.

However, it seems that in this country we are quite convinced that the simple receiver cannot give a good performance so that the small extra expenditure on tetrode or pentode valves for the detector is not deemed justifiable.

The increased use of A.V.C. has brought in its train the adoption of visual tuning in many cases. Visual tuners are only fitted on those sets which have A.V.C., the theory being that it is only because of the



Cabinets, too, have advanced in design! This photograph shows a new Ekco super-het with moving-coil loud-speaker housed in an all-bakelite cabinet. The large dial is a help for accurate station-getting

levelling action of the volume control that any kind of visual indication is necessary.

At any rate, 28 per cent of the sets are fitted with visual-tuning, which is approximately half the number of super-hets. Some of the manufacturers go to the trouble of coupling with the visual-tuning operation a squelch designed so that the noise between stations is suppressed.

Surprising Feature

Mains technique remains much about the same. Perhaps the most surprising feature of this season's models is the very small percentage of metal rectifiers employed, nearly 95 per cent of the rectifiers being valves. This is probably a swing of the pendulum, for a year or two back the metal rectifier was decidedly in the forefront.

The A.C./D.C. set seems to be feeling its way. Certainly there seems to be no point in producing D.C. sets any longer, because there is always the fear of a changeover at some future date, and it is no more difficult to produce a universal receiver than a plain D.C. one.

The output stage shows little development. The pentode seems to hold the field, the proportions of pentode, triode and class B being roughly 6 : 2 : 1. The response of most sets is woeful and no manufacturer seems to have thought it worth while to put out a medium-priced receiver with a good response and a sharp cut-off filter at 4,000 cycles.

Inspired by Valve Makers

Making a general survey of the whole situation the fact which stands out pre-eminently is that the present year is a valve year. Practically all the improvements effected are the results of new valves. The circuits are, in fact, inspired by the valve makers to a very considerable extent, so resulting in a rather unfortunate sameness in the different receivers.

There are, of course, a few excep-

tions to this, but as a general rule the new valves are produced with recommendations for circuits and the sets are built round these recommendations by the various manufacturers.

This state of affairs will not change in a hurry, although it is to be hoped that it will be modified in the future.

The reliability and simplicity of the super-het, par-



A new loud-speaker by H.M.V., and used in many of their sets, has two cones, one of metal and one of parchment, and is oval in shape to ensure good frequency response

ticularly as regards manufacture, will keep this form of circuit with us for some time yet. At the same time, if the ingenuity which is expended on developing special tracking circuits for super-het oscillators were applied to straight receivers, one is tempted to suggest that a better all-round performance could be obtained.

The outstanding advantage of the straight set over the super-het is freedom from noise, and it is no mean advantage. Philips were the pioneers of the really high-efficiency straight set, and it is interesting to note that one other firm (H. Hacker & Son) is adopting the same policy.

But I am not going to prophesy, because my feelings in the matter are too gloomy. I can see the line which developments could take, and which many of us would like it to take, but I fear the cold truth is that next year's sets will be the same as this year's with a few extra frills.



For simplicity it is hard to beat the ordinary straight three-valver as exemplified by the Cossor A.C. Melody Maker

There is just one other point I want to mention. This year has seen several commendable attempts to improve tuning dials and scales. But in these attempts the improvements effected have been offset, in

THE NEW HOBBY !

THOUGH no actual date has been fixed for the publication of the findings of the Postmaster-General's Television Committee, it is generally considered that it is imminent. Wireless enthusiasts would do well, therefore, to obtain up-to-date knowledge of this new and fascinating hobby.

Our sister journal, "Television" (1s. monthly) covers the whole range of television activities and provides information for novice or expert.

Features in the December issue include: Television Made Easy; The Simplest Cathode-ray Receiver; Modern High-definition Transmission; Recent Developments; Modern Physics and Television Research; together with all the latest news appertaining to this new hobby.

many cases, by making them too complicated or, in some cases, too small. Dials want to be fairly large and clearly marked in wavelengths, preferably.

About the cabinets themselves, there is little to say. Except in one or two notable cases, they are rather uninspired boxes. There is still plenty of room for new ideas in this channel of the industry.

Tests of New Apparatus

B.T.S. Low-frequency Transformer :: Formo Paper Condenser :: Goltone Whistle Filter :: Baker Extension Loud-speaker :: British Tungstram Valves

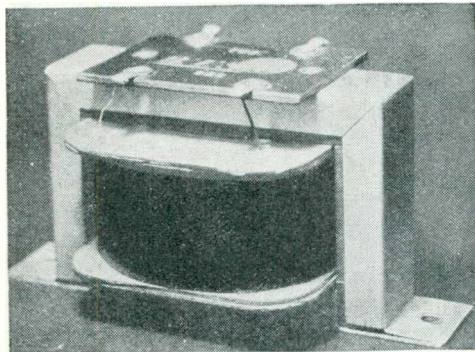

A real serviceable and efficient transformer is that made by British Television Supplies

B.T.S. TRANSFORMER

APPARATUS: Low-frequency transformer.
PRICE: £1 4s. 6d.
MAKERS: British Television Supplies, Ltd.

THIS new component just put on the market by B.T.S. is a robust and straightforward job in which all frills have been omitted. The primary and secondary windings are overwound, and the stampings are held together by a simple pressing which also serves for the feet.

The terminal connections are brought up to a small bakelised paper panel provided with four soldering tags.

On test we found that the transformer had a good performance. The primary inductance was 25 henries even with 15 milliamperes flowing, and as one might expect this maintains the amplification high even in the bass.

The effective step-up is 2.5 to 1 over most of the range, rising to a little over 3 to 1 at 4,000 cycles, after which there is a fairly sharp cut-off at 5,000 cycles.

This is a useful component and is particularly well worth its price.

FORMO FIXED CONDENSER

APPARATUS: Screened paper condenser.
PRICE: 1s. 9d.
MAKERS: Formo Products.

ONE of the Formo ranges which will appeal to the constructor is their screened paper condensers. These components are tubular in shape, the outer metal case acting as one of the poles, the other being connected to a small terminal in the top.

The component can thus be mounted like an electrolytic condenser directly on to a metal chassis, so simplifying the wiring, or it can, of course, be used as an ordinary condenser by simply connecting leads to either end.

The particular sample received was rated at .5 microfarad, and was found to have an actual capacity of .59 microfarad at 50 cycles. The insulation

object in view the coils are wound with Litz wire on an iron core.

The two coils are mounted at right angles to one another so that there shall be a minimum of interaction between them.

Tuning condensers are not included in the unit, these being provided by the user. It is stated that paper dielectric condensers can be employed if necessary, but if the full benefit of the coil is to be obtained an air-spaced condenser must obviously be used.

As an indication of the effectiveness of the device, we measured the voltage developed from the two London stations on a simple aerial coil. These voltages with a full outdoor aerial were 13.5 on the Regional programme and 6.5 on the National programme (which figures in themselves are evidence of the need for some such device as that



Rather unusual is the single terminal on the Formo condenser; it is ideal for constructors

resistance on a 500-volt Megger was infinite.

The unit is $\frac{3}{4}$ in. in diameter and 3 in. long, so that it is quite compact and will occupy little room.

GOLTONE WHISTLE FILTER

APPARATUS: Whistle filter.
PRICE: 8s. 6d.
MAKERS: Ward & Goldstone, Ltd.

PRINCIPAL whistles of a super-het are due to the general unwieldiness of the local stations, the voltage from which is far in excess of any normal signal voltage. No little improvement in the results can be obtained if the voltage from these stations can be cut down to a value more commensurate with that from distant stations.

This new Goltone Whistle Suppressor is designed with this object in view. It consists, in effect, of two wave-traps intended to be tuned to the two local transmitters. If the performance is to be effective the circuits must be sharply tuned, and with this

under test).

With the suppressor tuned to the respective stations the voltage from the Regional station was only .4 volt and from the National station only .15 volt.

This represents still quite a strong

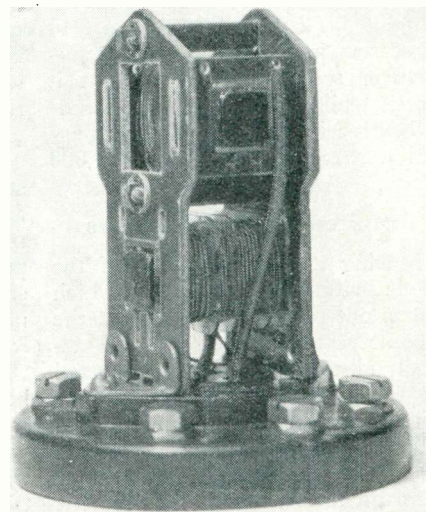

A really useful component for super-het enthusiasts is this Goltone whistle filter

signal to the average super-het, so that there is no difficulty whatever in receiving the local programmes, but the unpleasant whistles to which the super-het is heir are largely eliminated by the use of this device.

BAKER EXTENSION LOUD-SPEAKER

APPARATUS: Moving-coil loud-speaker.
TYPE: Fydelitone Minor
PRICE: £1 15s.
MAKERS: Bakers Selhurst Radio, Ltd.

AS most commercial and home-constructor sets make provision for the use of external loud-speakers it is surprising that we have not seen more moving-coil units such as the Baker Fydelitone Minor.

This unit has been designed for use in conjunction with another loudspeaker and, so that it can be accurately matched to give the maximum volume and quality, several tappings have been provided. These have been arranged so that it is possible to get a ratio suitable for almost any type of output valve.

The reproducer is very compact—the overall dimensions are $8\frac{3}{4}$ in. by 8 in. by 4 in., but even so the unit has been fitted with a large permanent magnet and has a diaphragm $5\frac{1}{2}$ in. wide.

It is claimed that this size diaphragm will give high-note response up to 8,000 cycles and is reasonably free from resonance.

One cannot expect full bass response with a small unit of this kind, but there is a measurable response at 100 cycles. Actually, quality is

quite good, particularly when it is fed with an input of 2 watts or more.

TUNGSRAM VALVES

APPARATUS: (a) 2-volt detector valve, (b) 2-volt pentode, (c) mains rectifying valve.
TYPE: (a) HR210, (b) PP220, (c) PV495.
PRICE: (a) 5s. 6d., (b) 14s. 0d., (c) 10s. 0d.
MAKERS: Tungram Electric Lamp Works (G.B.), Ltd.

THIS month we are reviewing some of the first products of the new British Tungram factory. The first two are battery valves—the HR210 and the PP220. They are both accommodated in the familiar dome-shaped bulb, but a new form of fitting is adopted for steadying the electrodes at the top.

Instead of the usual star-shaped mica washer, two mica flanges are fixed to the sides of the electrode assembly, and these fit tightly inside the dome top, taking up any

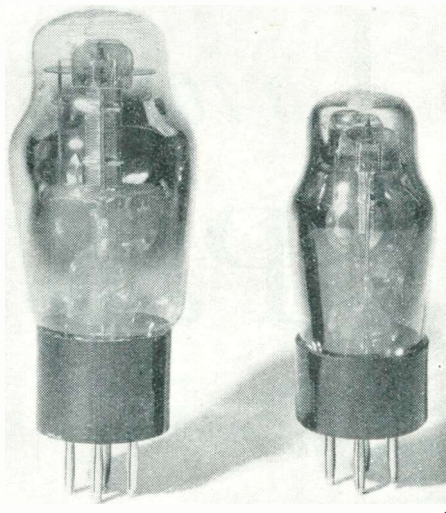

Showing the new dome-topped Tungram valves. The pentode is on the left; the other is the triode

irregularities by bending slightly at the edges. This construction should obviate, once and for all, any tendency to rattle.

The HR210 is a general-purpose triode having an amplification factor, as determined by our tests, of 22.5, an internal resistance of 16,000 ohms, and a mutual conductance of 1.4. These are slightly better than the rated figures which are 30, 23,000 and 1.3 respectively. The valve should make a good detector and will handle an input of over 1 volt as a grid rectifier.

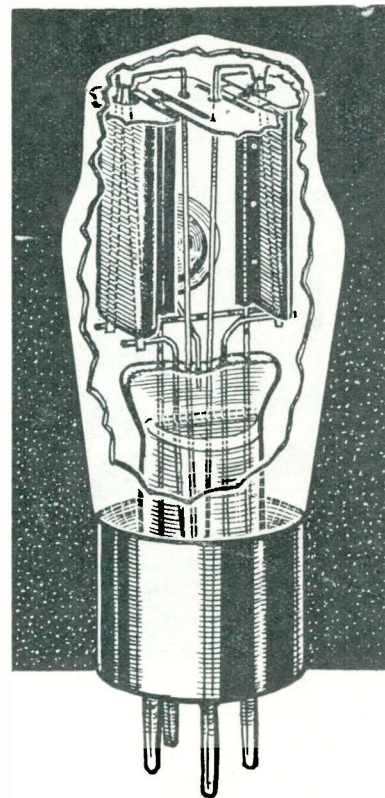

Our artist's drawing of the Tungram PV495 rectifying valve, showing the electrode arrangement

The PP220 is an output pentode, and is interesting in that the maximum anode voltage is 200 instead of the usual 150, so that the battery user who does not mind increasing his voltage can do so with a light heart.

Notwithstanding this increased voltage the anode current was barely 5 milliamperes with the rated voltages of 200 on the anode, 150 on the screen, and 6 volts grid-bias.

The rated optimum load is 14,000 ohms, but we found that it was necessary to use a rather higher value approaching 30,000 ohms. We were, however, able to obtain the rated 400 milliwatts output with this load without more than 5 per cent distortion.

Both these valves, in fact, are creditable productions and will be welcomed by battery users.

The third valve is a mains rectifying valve more or less of conventional construction. It is directly heated, and the anodes are blackened in order to improve their heat-radiating properties.

The valve is rated for 300-0-300 volts, 70 milliamperes, and we found that it not only stood up to its work but had rather lower internal resistance than usual.

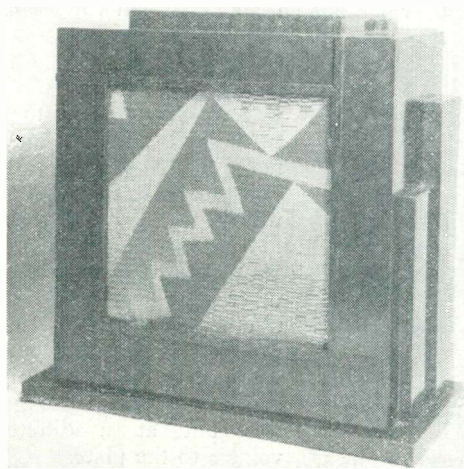

Ideal for all sets with extension loud-speaker terminals, the Baker Fydelitone moving-coil reproducer. We found that quality was good

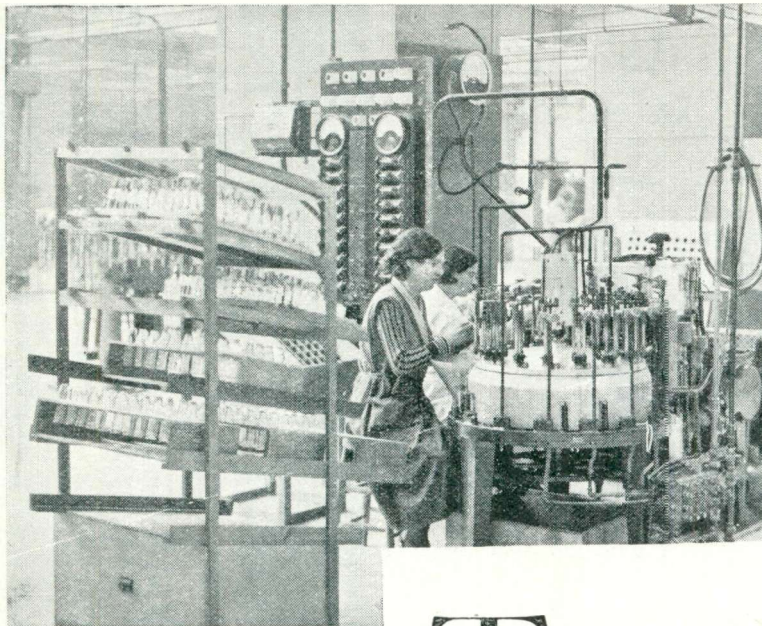

Girls at work in the new North London Tungsram factory, where thousands of valves are being turned out every week

THE behaviour of triodes is fairly accurately known; for instance, we know that if all other dimensions of the triode remain the same, then alteration of the grid mesh merely alters the M value and the resistance of the tube, and in general $\frac{M}{r}$, the mutual conductance, remains the same at the same milliamperes.

Island Building

If we open the mesh of a triode too much we get tailing—or, as the Germans call it, “island building”—because half-way between the curves the grid wires are so far from the electron stream that the voltage on the grid does not act on the stream.

M values of about 4 or 5 are about the lowest at which this does not happen and, consequently, valves with very low M values are not often used nowadays.

The LS5A is the lowest one I know, and this has an M value of 2, but often I have wanted a valve with a still lower value of M ; you can get large currents at low voltages with them, and if the grid input is not very important they are very useful.

Conversion

We can take any triode and convert it into a pentode by replacing the plate by a grid of fine mesh and inserting another plate; the third grid is only put

in to stop that kink in the curve which occurs in the tetrode. But what decides the triode which we will turn into a pentode?

For convenience, the screen grid of a pentode should be at the plate voltage—the high-tension voltage to be used is decided upon by the type of the set in which the valve is to be used, and the maximum milliamperes is decided by the watts the tube will stand.

Finding the Triode

Given all these conditions we can go ahead and find the triode which, when turned into a pentode, will meet them. Thus a valve of $\frac{M}{r} = 2$ and $M = 2$ will make an

Triodes versus Pentodes

By Captain H. J. ROUND, M.I.E.E.

equally good pentode to one with an $M = 10$ and $\frac{M}{r}$ of 2, but in the first case, the screen volts may have to be only 75, whereas if the M is 10 then the screen volts will have to be 150, which is a suitable common voltage for the plate.

M Value Above Tailing Value

Tailing may have to be considered also. I have never seen any reliable data on equal pentodes produced with a variety of M value for the inner grid, but I rather think that better tubes would be produced if the M value in a triode was chosen just above the value where tailing occurs, and where the screen grid was put at a different voltage to the plate.

In the ideal pentode, the M value and resistance

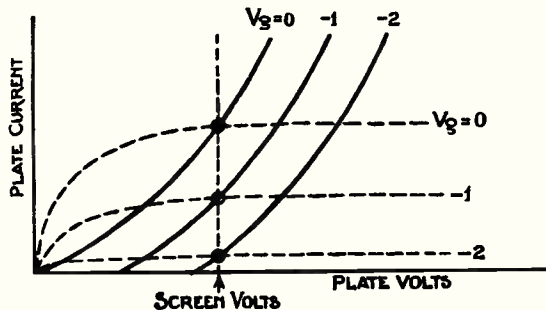

Fig. 1.—Showing how to construct a pentode characteristic from the triode characteristic. Thick lines represent triode curves and dotted lines the pentode curves

value are not to be considered; both are infinite; M/R , the mutual conductance, being, however, a finite value usually slightly less than when the valve is used as a triode because of losses in the screening grid.

Originally, the main object of the pentode was to enable us to get into that area of the valve characteristic where grid current flows in the triode, and thus get out more power economically, but a careful consideration of modern valves on the market shows that there is very little in this point nowadays when M/R values are very great and triode M values can be kept low. Later we shall see what is the remaining value of the pentode.

Valves With a Load

If we take any valve and connect it to a loud-speaker, we are loading that valve with a combination of resistance and inductance. This combination steadily increases in impedance as the frequency rises.

In using a triode, if the impedance of the loud-speaker is chosen so as to be, say, double the triode resistance at 100 cycles, then at 6,000 cycles the impedance will be many times this value.

Thus I recently measured the constants of a cheap moving-coil loud-speaker across the terminals of its transformer—the triode terminals—and it measured .6 henries and 5,000 ohms. At 100 cycles, the total impedance was practically 5,000 ohms, whereas at 6,000 cycles it was 22,000 ohms, and the total current that would be forced through the loud-speaker would be only one-third at 6,000 than it was at 100 cycles.



Above is seen one of the new Osram Catkin A.C. pentodes with a seven-pin base

Fig. 2.—Showing the connections of the load-speaker output in a pentode circuit to give constant impedance, but with a consequent drop in high-frequency response. Leakage due to the transformer is an important item to keep small. Either position of resistance and condenser can be used but, of course, the values are different in each case

Fig. 3.—The load-line curves of a pentode with a pure inductive load showing how rise of frequency with the same grid swing will produce distortion. A, B, C, D, E—load lines with increasing frequencies. This type of overloading usually shows as a drop in milliamperes in the plate circuit

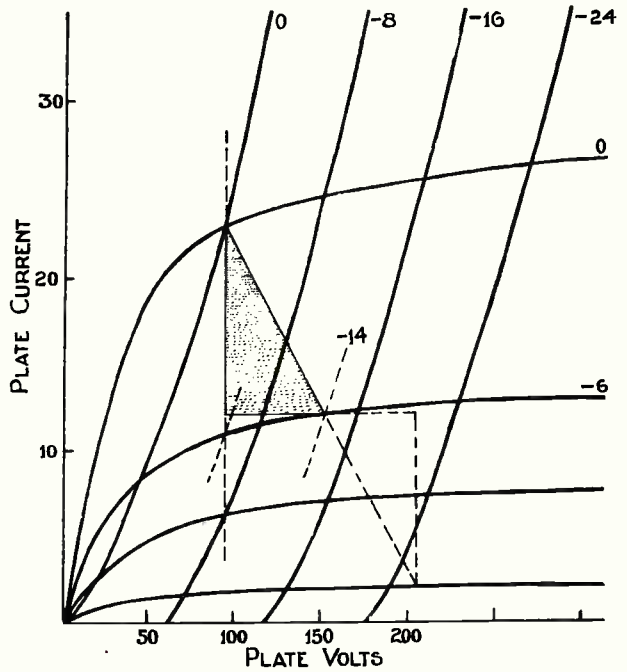

Fig. 4.—A P2 valve converted into a pentode with about 100 volts on the screen grid showing same load conditions suitable for either triode or pentode, but how the triode requires about 14 volts grid swing against the pentode's 6 volts

The current decreasing keeps the volts from rising across the loud-speaker but, of course, our loud-speaker is working under conditions which do not seem to be right. Theoretically a moving-coil reproducer should have equal current through it at all frequencies to produce equal acceleration and equal radiation of sound, but owing to practical defects in loud-speakers, this falling current characteristic seems to suit the designers very well.

Pentode Blasting

Now the pentode in the limit has an infinite R and an infinite M . No varying impedance of loud-speaker can alter the current. The current is controlled entirely by the valve so that the pentode gives us constant current, but a little consideration will show that this must be

accompanied in a moving-coil loud-speaker with a rising voltage with frequency, and this voltage may very easily get out of hand and, in fact, is the cause of much trouble.

In a pentode with an inductance load, however small the inductance and however small the input, blasting will occur at some frequency because the voltage across the inductance will rise steadily with the increase in frequency until this voltage is more than the voltage on the anode will permit.

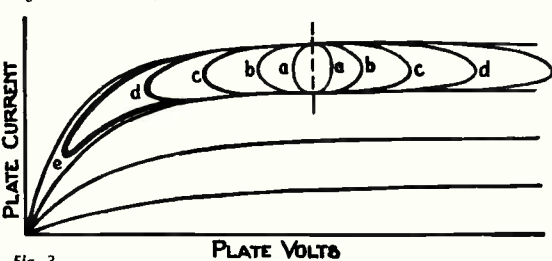
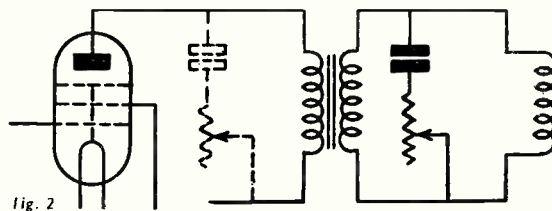

It is rather a curious point with a pentode that if sufficiently high an inductance load is chosen and sufficiently high frequency, the plate volts on the pentode may be made to swing between nearly zero and voltages many times that fixed on the plate—well up to a sparking voltage.

These effects cannot normally be produced with a triode, since the falling characteristic in the triode will in a certain way prevent blasting.

It is, of course, possible to correct this fault in the pentode in several ways, but every way ends in a falling characteristic of current in some form or other, though probably not so bad as with a triode.

One common way is to shunt the loud-speaker with a condenser, sometimes in series with a resistance. Thus on one cheap loud-speaker I have, a 10-microfarad condenser with a 2-ohm. resistance in series across the loud-speaker produces roughly a constant impedance with, of course, a slow cut off of current to the loud-speaker as the condenser comes into action. The more the load can be resistive and not inductive the better, and a common fault is to use a transformer with a large magnetic leakage.

This cheap loud-speaker I have mentioned has a leakage inductance equal to the loud-speaker's inductance, thus making the trouble twice as great as it need

be. The primary inductance of the pentode transformer has to be larger than with the triode to prevent bass cut off, and this still further adds to magnetic leakage trouble.

Fortunately with moving-coil loud-speakers, the falling characteristic of current seems to be best, so that these correction stunts do not do any harm.

Assuming we can stop the high-frequency blasting in the pentode then perhaps it is fair to compare the triode and pentode for output power at a low frequency, giving the pentode the benefit of producing improved top frequencies.

In the last figure of this article, I have given the characteristic of a P2 valve and superimposed on it I have drawn a pentode characteristic developed from it. It will be seen that the same load triangle suits both valves and very little power gain can be obtained from the pentode, but if we compare the grid swings in the two cases, it will be seen that only one-third the voltage is required to drive the pentode.

It is, of course, possible to consider the pentode developed from this triode giving a little more power than the triode at a higher grid voltage, but at the expense, of course, of more grid swing. We could counter this in the triode by lowering the M value.

Continued on page 476

A New Use for Old Valves

IN a note published in the November "W.M." I discussed the possibility of using old valves which have lost emission in the place of a diode detector in a super-het.

Their success there depends on the fact that an emission of only a few microamperes is required to supply the grid current.

Similar Conditions

Similar conditions exist, though the current consumption is of the order of 1 milliampere, in the case of the cathode-ray oscillograph as used either in television receivers or in laboratory instruments.

There, anything up to 1,000 volts may be required for the anodes and something like 100 to 200 volts for the Wehnelt cylinder. For successful operation these voltages must be quite steady if modulation of the electron beam is to be avoided.

Fortunately, the current consumption is extremely small (not more than 100-200 microamperes) and therefore it becomes possible to obtain a variable voltage control by means of a voltage divider and still obtain adequate smoothing with chokes and condensers of quite moderate values.

Moreover, although the voltage regulation of a voltage-doubling circuit is normally somewhat poor, in this case it can be quite sufficient for the purpose so that

the high voltage may be obtained by means of a mains transformer wound for only the usual 250-0-250 high tension on the secondary side.

The circuit, illustrated on this page, which I saw in an American journal some twelve months ago, ingeniously takes advantage of these facts. Indirectly-heated valves are used as rectifiers in a voltage-doubling arrangement and these may be triodes with grids (or anodes) left unconnected. Separate filament windings are necessary on the mains transformer, otherwise there would be a very large difference of potential between filament and cathode in one of the valves. The reservoir and smoothing condensers must be rated to stand high voltages of 1,500 volts.

P. Wilson, M.A.

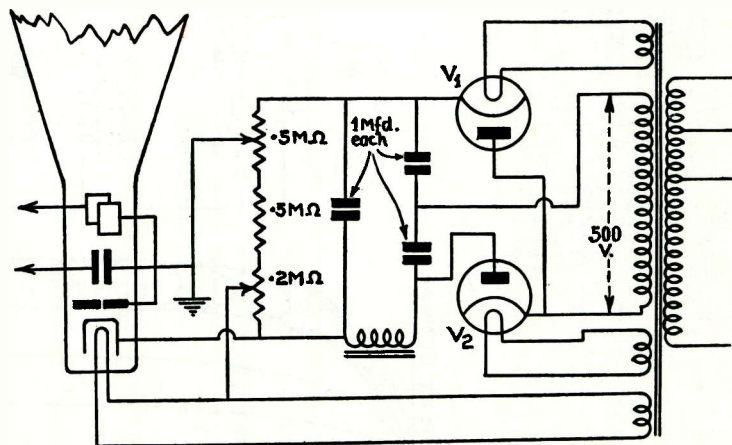

Here indirectly heated valves are used as rectifiers in a voltage-doubling circuit. These may be triodes with grids or anodes left unconnected

Mysteries of Station Fading

By E. H. CHAPMAN, M.A., D.Sc.

Many readers will remember an article, "Measuring the Ups and Downs in Signal Strength" by Dr. Chapman, which appeared in the October "W.M." There it was shown how, with the aid of a simple Moullin voltmeter, it is possible to obtain diagrammatic records of received signals.

This month Dr. Chapman recalls experiments in tracing the stations which fade most. Readers can try these experiments on their own sets

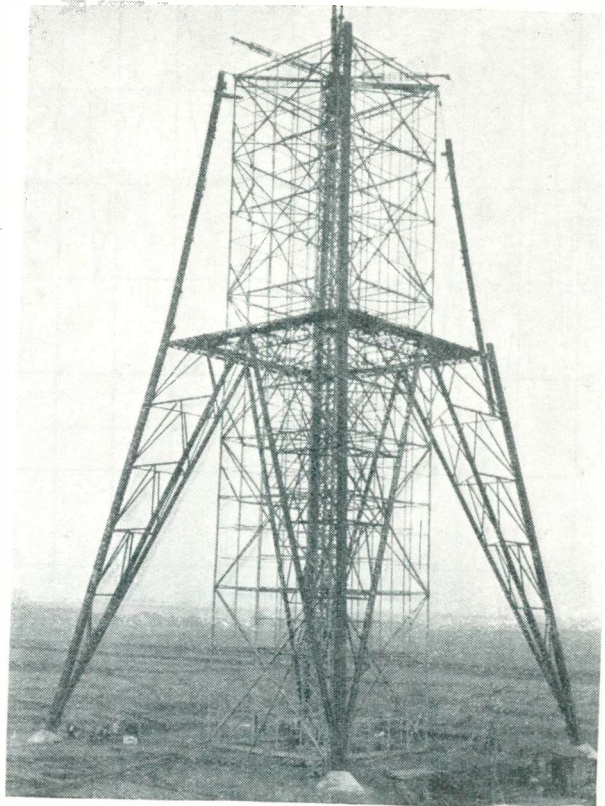

Gulliland photo

German radio technicians are fighting against fading effects by erecting specially designed aerials to counteract fading. This photograph shows the new Hamburg aerial in the course of construction. The tower is made of wood

FADING is no longer the bugbear it used to be: automatic volume control has altered all that. But automatic volume control has not killed our interest in fading. On the contrary, it may safely be said that it is impossible to understand what automatic volume control is, or what it is there for, unless one knows something about fading.

Now, automatic volume control is a device which, working *inside* a

wireless receiver, checks the irregularities in signal strength due to fading. Automatic volume control does not *cure* or *prevent* fading. Nothing apparently can do that.

All the time your automatic volume control is working efficiently on a distant broadcasting station, fading is taking place in exactly the same way it was taking place before your automatic volume control was designed. Remove automatic volume

control from your wireless set and fading is there to be studied just as it has been from the beginning.

Fading is one of radio's most mysterious things. The usual explanation of fading is as follows. Wireless waves from a distant broadcasting station travel upwards into the upper atmosphere. These waves are reflected back to earth by the so-called Heaviside Layer.

Like a Rough Sea

If this reflecting layer in the upper atmosphere were quite smooth and perfectly still, there would be no fading. The under surface of the Heaviside Layer, however, is supposed to be corrugated, or otherwise irregularly shaped, and it may be moving up and down like the surface of a rough sea. Thus reflection from it is erratic.

At one moment a downward reflected wave hits your receiving station, the next misses it. Whether we accept this explanation as adequate or not is immaterial. We know that fading does occur and any one of us can observe the pranks it plays with wireless reception.

TABLE I

Station	Distance in miles	Direction	Average fading period minutes	Average number of fading swings per hour
London Regional ...	170	ENE	1 1/2	50
Midland Regional ...	170	NE	1 1/2	45
Radio Normandie ...	180	ESE	1 1/2	45
North Regional ...	220	NNE	2 1/2	24
North National ...	220	NNE	2 1/2	24
Poste Parisien ...	300	SE	3	20
Scottish Regional ...	380	N	3	20
Stuttgart ...	600	ESE	5	12
Munich ...	700	ESE	6	10
Leipzig ...	750	E	5	12
Vienna ...	900	ESE	15	4

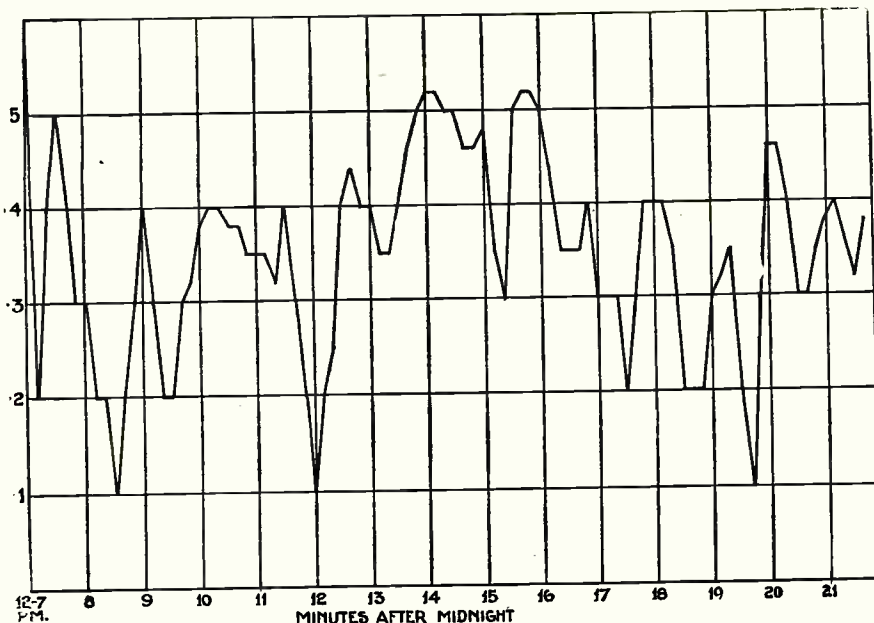

MEASURED STRENGTH OF FECAMP AFTER MIDNIGHT
 Fig. 1.—Dr. Chapman's graph of the measured signal strength of Radio Normandie between 12.7 and 12.21 a.m. The measurements were made in Devon, about 180 miles from Fecamp

Now in watching the effects of fading on the reception of a distant broadcasting station, the first thing to determine, perhaps, is the rate at which fading occurs. We must find out whether the ups and downs of signal strength occur every few minutes, or whether these ups and downs are spread over longer periods of time.

Fecamp Observations

Let us consider Fig. 1, which illustrated the effects of fading on the reception of Radio Normandie, situated 180 miles away E.S.E. of my receiving station. The observations shown in this diagram, and all the other observations shown or referred to in the present article, were made by means of a Moullin voltmeter.

This voltmeter was placed across the grid-filament coil of the detector valve of my receiver. A screen-grid valve preceded this detector valve, and there were two low-frequency amplifying valves following.

Pointer Movements

Fading is shown by the movements of the pointer of the Moullin voltmeter, and the effects of fading are heard in the loud-speaker at the same time.

In the case of Radio Normandie, fading was so rapid that I had to take a reading of the Moullin voltmeter every ten seconds. Altogether, I took eighty-nine readings in just

under fifteen minutes. These readings are shown in Fig. 1.

What is the first point to note about the diagram in Fig. 1? To my mind, the most striking feature of this diagram is the irregularity it shows in the effects of fading. The ups and downs of signal strength do not occur at regular intervals of time. They seem to occur in the most erratic manner. It is this irregularity, perhaps, that makes fading so difficult to explain.

On further consideration of Fig. 1 we note that there are eleven ups and downs, or "swings" of signal strength due to fading. The total time taken for the eighty-nine observations was 14 minutes 40 seconds. Dividing this total time of 14 minutes 40 seconds by 11, the number of "swings," we get an average time period per swing of 1 minute 20 seconds.

Bearing in mind this average time period for the fading of Radio Normandie, let us pass on to a consideration of the next diagram, Fig. 2.

The observations shown in Fig. 2

refer to Vienna, which is 900 miles away to the E.S.E. of my receiving station. There is something rather interesting about these observations. For three nights in succession, I watched and listened to the Vienna station for five minutes or more just after 11 p.m.

Little Fading

The amount of fading as shown by my Moullin voltmeter was very little. I had come to the conclusion that the Vienna transmission did not fade very much. Fortunately, I tuned in to Vienna on the fourth night about the same time after 11 p.m. There was a slight rise in signal strength during the first three minutes of reception. I expected the rise to stop at that, but it did not.

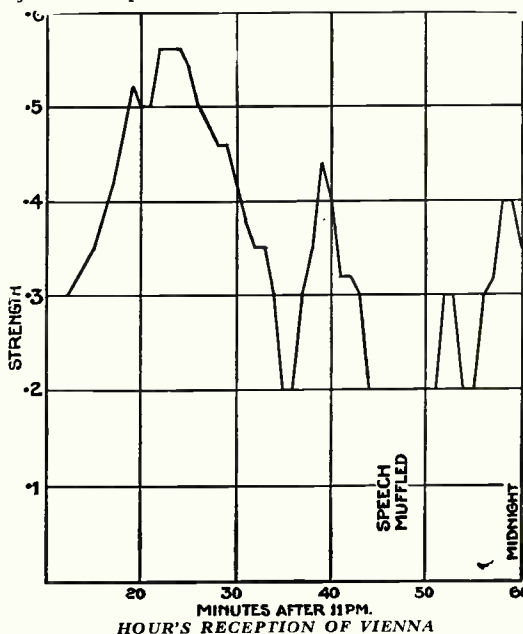

Fig. 2.—Showing a graph of the signal strength from Vienna, which is 900 miles from the receiving station. Quite different from Fecamp's graph shown in Fig. 1!

To my surprise, the rise in signal strength continued for another four minutes. At the end of that time the signal strength of Vienna, as shown by my Moullin voltmeter, was almost double what it was when I had first observed it.

I was so interested that I watched the Vienna transmission by means of my Moullin voltmeter for forty-eight minutes; in fact, until midnight.

Since fading was taking place slowly, it was only necessary for

me to take a reading each minute. These minute observations are shown in Fig. 2.

The curve of Fig. 2 shows four maximum and three minimum values in the received strength of the Vienna transmission. Neglecting the last maximum value, there are very nearly three complete "swings," the first swing not being quite complete at the start. We should not be far wrong in concluding that the three complete swings took place in 45 minutes, giving an average fading period for Vienna of 15 minutes—a very different average value from that of 1 minute 20 seconds for Radio Normandie.

Average Fading Periods

Working in exactly the same way as for Radio Normandie and Vienna, I have found the average fading periods for nine other broadcasting stations. The values obtained are set out in Table 1. A mere glance at this table is sufficient to show that this average fading period is somehow or other connected with distance. The nearer stations fade much more rapidly than the more distant stations.

Distance Counts

London Regional and Midland Regional, 170 miles away, and Radio Normandie, 180 miles away, fade four times as rapidly as Stuttgart, 600 miles away, Munich, 700 miles away; and Leipzig, 750 miles away.

Thus, if automatic volume control was at all susceptible to rapidity of fading, it would work more efficiently on the more distant stations than on the nearer stations.

The second important point to consider with regard to the fading of a distant broadcasting station is the amount of fading which takes place. For example, in my district, the powerful Poste Parisien transmission gives reception which, after dark, dwindles from mighty volume to a mere whisper.

The Scottish Regional transmission does not vary as much in signal strength after dark as the transmission from the much nearer North Regional station. Judging the

amount of fading by listening to the volume of sound coming from a loud-speaker is apt to be deceptive. The ear cannot be relied on altogether in such work.

It is better to measure the amount of fading instrumentally. A Moullin voltmeter connected to a wireless receiver, as previously described, is an excellent instrument for such work.

The method I have used to measure the amount of fading of a distant broadcasting station is to watch the pointer of my Moullin voltmeter and to note the highest and lowest readings over a period of time. The difference between these two readings gives me a measure of the amount of fading.

In this way I have measured the amount of fading of twenty-seven broadcasting stations. The results of these measurements are given in Table 2. The Moullin voltmeter is graduated in volts and fractions of a volt from 0 to 1.5 volts.

In order to avoid fractions, I have multiplied my readings by 100. The amount of fading for each of the twenty-seven stations in Table 2 is based on three or more sets of

TABLE II

Station	Distance in miles	Figure of fading
West Regional ...	48	6
Midland Regional ...	170	45
London Regional ...	170	60
Radio Normandie ...	180	45
North Regional ...	220	60
North National ...	220	40
Athlone ...	250	40
Poste Parisien ...	300	80
Brussels I ...	380	45
Brussels II ...	380	50
Scottish Regional ...	380	30
Scottish National ...	380	35
Bordeaux ...	400	30
Hilversum ...	400	40
Cologne ...	480	45
Toulouse ...	500	40
Beromunster ...	600	45
Stuttgart ...	600	25
Lisbon ...	700	25
Leipzig ...	750	40
Prague ...	800	35
Florence ...	900	20
Horby ...	900	20
Vienna ...	900	35
Rome ...	1,000	30
Budapest ...	1,100	20
Belgrade ...	1,200	30

readings taken on different nights.

It is a little difficult to draw any definite conclusions from the fading figures in Table 2. There are, of course, differences in wavelength and in power between the twenty-seven stations, and these differences may affect the fading figures. If, however, these figures representing the amount of fading are shown in the form of a diagram, as in Fig. 3, and if we are sufficiently venturesome to draw what we might call a curve of average fading with distance, certain conclusions suggest themselves.

In the first place, it is clear that fading, which as we know, is very slight for stations within fifty miles, increases rapidly with distance up to 300 miles. From 300 to 400 miles fading decreases quite rapidly as Fig. 3 shows.

After 400 miles, fading decreases more slowly, until, at 1,000 miles or more, the amount of fading is about the same as that for stations between 100 and 150 miles distant.

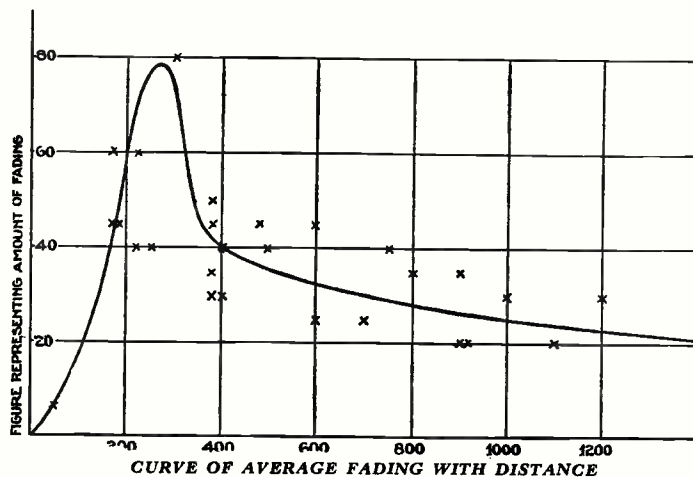

Fig. 3.—A curve showing the proportion of fading compared with the distance of the station from the receiving point. It will be seen that the worst fading occurs with stations about 230 miles from the receiving point



Part of the extensive radio test section of the vast Coventry works of the G.E.C., which turns out two radio sets every minute

down to a definite basis than any other, because there are more variables to be taken into account. Some confusion has already been caused by the use of different standards in England and America, together with a certain amount of "wangling" by individual makers wishing to quote a good figure of merit for their products.

However, there is now general acceptance of the following definition: the sensitivity of a receiver is the number of microvolts input between aerial and earth terminals which will produce an output of 50 milliwatts in the loud-speaker circuit. The measurement is to be made under the following conditions:

Microvolts in Your Aerial

WE shall be hearing quite a lot about Microvolts next year.

These shy little creatures have long been friends of the professional engineers in their laboratories, where they are thoroughly at home. Now, however, it has been decided that they are to enter a wider sphere, and it will not be long before they become as much sought after as their big sister, Milliwatts!

Definite Trend

Seriously, though, there is a definite trend towards closer specification of what modern receivers will do, and a knowledge of the real meaning of all the terms involved will be essential to every radio man.

Microvolts-sensitivity

We are familiar with the meaning of milliwatts output, and most of us will understand the significance of 9-kilocycle selectivity, or of 50-5,000 cycles response, but now, in addition to all these, we shall be asking for the microvolts sensitivity of the set in which we are interested.

These criteria of performance are all relative, in that we define them by figures based on certain arbitrary standards, chosen in the light of experience.

Thus our figure for output usually implies an

allowance of some 5-7 per cent total harmonic as the amount of distortion which can be tolerated by the critical listener, while the response is regarded as substantially level over the range of frequencies containing no variations on output exceeding, say, 5 decibels, which would be undetectable on even a simple piece of music.

The figure for receiver sensitivity is more difficult to pin

(1) The output load to be non-inductive and correctly matched to the output valve for maximum power output.

(2) The radio input to be modulated 30 per cent at 400 cycles.

(3) The test to be made at a number of radio frequencies, generally 3 or 5, covering each waveband.

(4) The input to be applied to a standard dummy aerial, having a series capacity of 200 micro-microfarads, a self-inductance of 20 microhenries, and a resistance of 25 ohms.

Let us take these points one by one and see the reason for them.

An output of 50 milliwatts sounds very small in these days of 3-watt valves, but it is a fact, proved by many series of measurements, that this is a close approximation to the average level used at home.

The interesting experimental wattmeter shown by Westinghouse at Radiolympia demonstrated this to many visitors. Thus in

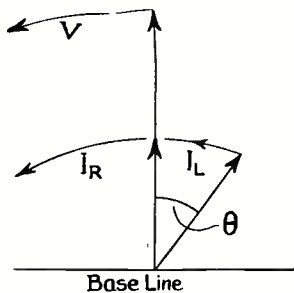

Fig. 1(b).—Imagine these arrow heads rotating anticlockwise. The distance from the arrow tips to the base line is shown by the curves in Fig. 1(a). See how I_L lags behind V by an angle θ

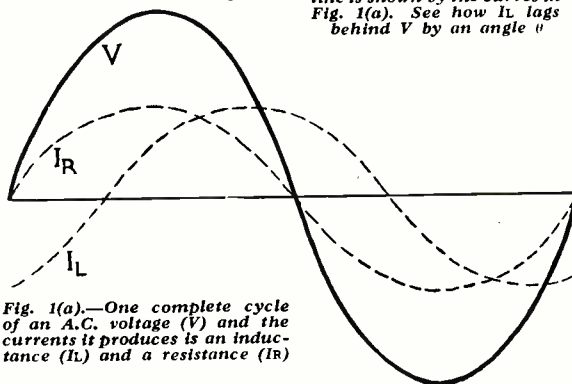

Fig. 1(a).—One complete cycle of an A.C. voltage (V) and the currents it produces is an inductance (I_L) and a resistance (I_R)

measuring the radio-frequency input which will give this output we are getting at a fair figure for the overall sensitivity of the set under working conditions.

At Optimum Value

The valve anode load is fixed at the optimum value, because at this low output it would be possible to use a high load without introducing distortion, and so to push up the apparent sensitivity.

Further, a resistance is stipulated in order to eliminate the errors which may be introduced by the phase difference between voltage and current in an inductive load.

Look for a moment at Fig. 1(a), which shows an A.C. voltage v , which we can assume to be applied to a resistance R or an inductance L ,

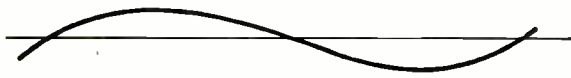

Fig. 2(b).—The audio frequency, in this case 50 per cent of the carrier amplitude

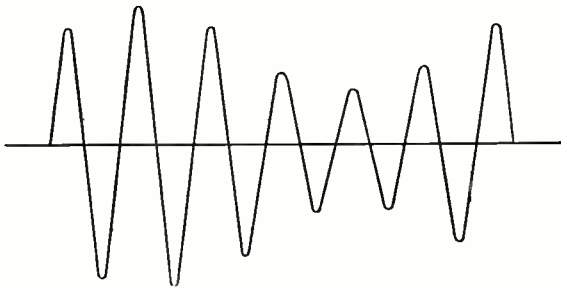

Fig. 2(c).—The modulated carrier. When measured on a high-frequency meter will give the same reading as Fig. 2(a) irrespective of value or frequency of 2(b), as long as 2(b) does not exceed amplitude of 2(a)

giving the resultant currents I_R and I_L .

We have chosen R and L to give the same current in each case, but it is easily seen that while I_R is exactly in phase with v , I_L lags behind it, owing to the inertia effect of inductance.

Removed Variable Factor

The power in the load, in watts, is given by $w = v \times i \times \cos \theta$, where θ is the angle of lag, or phase angle. In the case of the resistance, θ is zero, and $\cos \theta$ is 1, so that $w = v \times I_R$, but when θ has a finite value, as it will with an inductive or capacitive load, then $\cos \theta$ is less than 1, and w is less than $v \times I_L$.

The snag lies in the fact that the lag depends not only on the inductance and the frequency, but also on the resistance and self-capacity of the load, so that it varies quite widely

in different transformers and speech coils of the same inductance but different design. By specifying a resistance this variable factor is removed.

Now we come to the question of modulation. The reason for the use of a definite low frequency is obvious, but modulation is not quite so clear.

The broadcast transmission consists of a radio-frequency carrier (Fig. 2a) modulated by an audio-frequency voltage (Fig. 2b). Our aerial receives the combination (Fig.

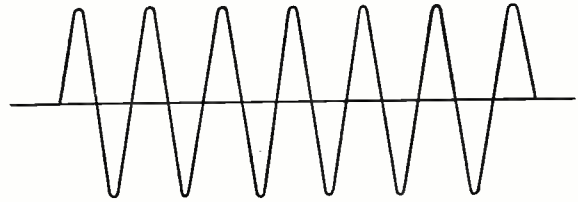

Fig. 2(a).—The broadcast transmission consists of a radio-frequency carrier

2c) and the radio-frequency stages—in which we can include super-het intermediate frequency—amplify it as such.

But the detector gets rid of the radio-frequency component, and hands on the amplified audio-frequency voltage only. It is therefore essential for us to know the relation between the original radio and audio components, as our *input* measurement

is at radio frequency, and will not take into account the modulation, but only the average carrier amplitude.

It can now be seen that the measured sensitivity of the set can be increased by using a higher percentage modulation, without altering any other condition, and if in doubt it is as well to be sure that when a comparison is made the basis is the same for the receivers under consideration.

The sensitivity of most receivers varies with wavelength, and is usually greatest at the lower end of each band. This is due to a number of causes, the chief of which are that the capacity across tuning circuits is lower, the incidental feedback effects are greater, and that ganging is usually carried out in this region, as it is the most critical in this respect.

Hence the necessity for measurement at more than one point, which is also a check on the accuracy of design and alignment of the tuning circuits. A good set may not vary more than 3 or 5 to 1 over each band, whereas a poor design may range

over 25 to 1! The figure usually quoted is that for 250-300 metres.

Last of all, aerial conditions must be fixed in order to ensure that the input-circuit design is taken into account. In practice this has to be proportioned to take care of a very wide range of aerials, and if we were permitted to adjust the test aerial to the optimum for the set, a marked rise in efficiency would result.

Essential for Comparison

Microvolts sensitivity is thus one of the essential bases for comparison of modern sets. No reputable factory would pass out a chassis which had not satisfied the "gain-test" inspector, and great ingenuity is exercised in the design of test benches which will fulfil all the conditions we have discussed, yet on which a set can be checked at six to ten wavelengths in a few moments.

Typical mean figures for different types of receiver are:—

	<i>Microvolts.</i>
Three-valve battery	.. 150-250
Three-valve mains	.. 100-200
Three-four valve super-het	10-100
Five-seven valve super-het	1-20
Multi-valve receivers	.. .5-5

Wide Variation

The variation is wide, even in each class, so that it is as well to have some idea of what the figures mean. When can one use the high sensitivities, and what will these sets receive?

Well, in an average suburban situation a sensitivity of 100 microvolts will usually mean reception of any station which will give real entertainment above local noise level.

Continued on page 478

Choosing Your Records

We Help You to Pick the Best Records for Your Radiogram

THIS month I have divided up the records—just anyhow. I suppose I feel that way. Anyway, you shall have your light entertainment first.

Like a noisy one to start with? H.M.V. B8229 has good tune on it with massed bands playing a march one side and the Welsh tune *Aberystwyth* (what a word that is!) on the reverse. Very good, too!

Now a Regal-Zonophone (MR1437, 1s. 6d.) Scenes from *My Old Dutch*, with Betty Balfour as "Lil" and Michael Hogan as "Bert." Quite good and thoroughly Cockney!

Brunswick (01858, 2s. 6d.) has produced a good light record of *Valse Bluette* and a *Faust* medley, with Victor Young and his orchestra. Very good surface and production generally worth notice.

A Decca 12-incher of the Berlin Philharmonic playing light excerpts from Strauss' *Schlagobers* is one of the best recordings of the month (LY6098, 3s. 6d.). You had better hear this.

Definitely worth buying is Columbia DB1440, 2s. 6d., because it is Van Phillips' orchestra and the oboist is Leon Goossens. They play *Salut d'Amour* delightfully: woodwind always records well.

Decca K740 (3s.) is called *Eric Coates Parade* with the Alfredo Campoli Grand Orchestra playing all his most popular melodies. This is a good band and you know the material well!

Max Rosen, violinist, plays two delightful little works called *Souvenir* and *Serenade*, accompanied by piano, on Brunswick 01841 (2s. 6d.). He is an expressive player and the music is attractive.

A good "talking" record with Edna Best and Ivor Novello is H.M.V. C2697 (2s. 6d.), where they give an excerpt from *Murder in Mayfair*. Very well done. Their inflection is so good—his especially.

A kiddy's record suitable for the Christmas season is *Noah's Ark*, on Columbia DX625 (4s.). It is arranged by Henry Hall and played by—well, you know. Well up to standard! Good vocal choruses.

Thinking of the B.B.C., there is an excellent rendering by the B.B.C. Wireless Chorus on a record called *Mystic Woods*. Very smart singing. I think I would like it. (Columbia, DX623, 4s.)

Now a couple of violin solos for you. Both by Columbia. A 10-incher of Albert Sandler (DB1428, 2s. 6d.) and a 12-incher (by Sandler also) on DX621 (4s.). The larger disc shows him to advantage in Massenet's *Meditation*.

Now two tenor soloists and one bass—a deep one—

Jetsam. He does *Gentlemen, Goodnight* and *In Praise of Ale* on Columbia DB1438 (2s. 6d.), as only he could. Topping! The first tenor is Turner Layton, who sings *Moon Glow* (Columbia DB1444, 2s. 6d.) from the *Blackbirds* of 1934 very effectively.

The other is an H.M.V. re-recording of Caruso. You pay for it, of course, but it is wonderfully good. One of his songs is *Because*. If you cannot imagine *Because* sung by Caruso you must get DA1380 (4s.). Then you will have no need to imagine it.

My next is a magnificent recording of Brahms' *E-mirror Symphony*, played by the B.B.C. Orchestra under Bruno Walter, who is an authority on Brahms.

Four Parlophone records have come in at the last moment. R1945 (2s. 6d.) is a dance orchestra. Nothing extra special except that it is a very nice dance orchestra



H.M.V. photo
A scene inside the H.M.V. studio with Noel Coward recording the new songs he sung recently in a broadcast Saturday Guest programme. Carroll Gibbons (on the extreme right) is directing the orchestra

—Robert Renard's. If you have not heard it a chance offers here.

Tauber again. He is getting very Anglicised, surely? RO20262 (4s.) finds him singing *Little Grey Home in the West*, with *In Your Arms Tonight* on the reverse. When these big tenors sing songs of this ballad kind they don't lower themselves but raise the dignity of the songs.

I don't mean that rudely to either song, but ballads are not the height of art, anyhow. On the other hand, Tauber is capable of singing opera. You should buy this record. It is very good.

The same remarks do not apply to RO20264, where Tauber is singing theme songs from *Blossom Time*,

By

WHITAKER WILSON



Regal-Zonophone photo

Lew Stone and his band are here seen making their first record for Regal-Zonophone. This famous radio band, as you know, are on the air every week

There is plenty of pep in Billy Cotton's band. This is Billy!

because the songs are by Schubert, the prince of song writers. Tauber is a great singer.

Finally, Marcel Palotti playing the organ—I don't know where—but one side is Moszkowsky's *Serenata*

and the other Rachmaninoff's popular *Prelude*. The former is the more successful, but both are good. Organ records, as you know, are not all they should be usually.

I must close on a fashionable topic. The rage in the light-music world, as far as piano solos are concerned, anyway, are the medleys recorded on Sterno by Charles Kunz. There are several kinds to be had—waltz medleys, old-fashioned and fox-trot sorts. They are all double-sided records and cost 1s. 6d. each.

Next month I hope to devote a considerable amount of my allotted space to seasonal discs.

LIGHT ORCHESTRAL

★**Bolero**, Harold Ramsay and His Rhythm Symphony, **DECCA F6236** 1s. 6d. This is, of course, a shortened version of this great musical scream—pardon the expression! Anyway, this version has been passed personally by Maurice Ravel. That should be enough! You can hear "Bolero" over the air, played by the B.B.C. Orchestra on December 5. Listen!

Sousa Marches, Jack Hylton and His Orch., 1s. 6d. **DECCA F5216**

Christmas is in the offing so it seems, for the record companies are getting right back into form with some real lively discs. Here's a good one. Jack Hylton produces a stirring dance-band arrangement of some of Sousa's best marches. You all know them—"Washington Post," "El Capitan," "Stars and Stripes," "Liberty Bell" and "King Cotton"—are some of them. This disc needs little recommendation—its the goods!

(a) **The Mosquitoes' Parade**, (b) **Whistling Rufus**, B.B.C. Dance Orch., 2s. 6d. **COL DB1441**

A couple of B.B.C. Band kiddies specials! Plucked strings, whistling solos and "loveless" choruses coupled with good recording. Vocal choruses are, I think, by Les Allen.

Records Reviewed By Chopstick

The B.B.C. band is particularly good at this sort of thing.

ZYLOPHONE SOLO

(a) **Over the Sticks**, (b) **The Dance of the Octopus**, Rudy Starita, 2s. 6d. **COL DB1435** This man's speed amazes me, and, believe me, it will amaze you. (a) is played at a terrific speed, mostly on the xylophone; (b) on the other hand, is a weird affair, which Rudy plays on the marimba. Creepy, I call (b)!

PIANO SOLO

★(a) **Marigold**, (b) **Ace of Spades**, Mr. and Mrs. Billy Mayerl, 2s. 6d. **COL DB1445** Perfectly charming, this! You may remember we had a photograph of Billy and Mrs. Mayerl on this page last month. I dare not criticise Mr. Mayerl's technique, it is far too good. The tunes are not new; (a) is quite an old favourite. You must get this disc; it deserves two stars.

ORGAN SOLO

★(a) **I Hate Myself**, (b) **Love in Bloom**, organ solo by Sidney Torch, 2s. 6d. **COL DB1446** (a) first. Great this! Hot rhythm played well on a cinema organ is a

treasure that is seldom heard. I remember hearing a record some twelve months ago played by Torch called "Hotter than Ever." This is on the same lines. The effects this artist gets on his Christie organ at the Regal, Marble Arch, are truly amazing. Columbia has done its part well, the recording is without a blemish. (a) is a contrast in which Sidney Torch makes use of a peculiar set of stops that sound like a cross between a piano and a harp. Get this; the best record of the month!

DANCE MUSIC

(a) **Isle of Capri** (f.), (b) **Ole Faithful** (slow f.), Billy Cotton and His Band, 1s. 6d. **REGAL-ZONO MR1426**

I like this band, although I think Billy Cotton has treated (a) a shade too roughly. It is a tune that needs "gliding through." The fault, though, is not sufficient to stop me recommending this as one of the best eighteenpenny dance records that has been released for some time. You will like "Ole Faithful."

★(a) **Soon** (f.), (b) **Ole Faithful** (f.), Jack Jackson and His Orch., 2s. 6d. **H.M.V. B6530** The Jack Jackson record of the month. Well up to usual standard. Ideal for dancing, perfectly recorded and a couple of good tunes. Starred, of course!

★(a) **Three Little Fat Girls** (t.), (b) **Lost in a Fog** (f.), Harry Roy and His Band, 2s. 6d. **PARLO R1938**

Typical of Harry's nonsense—great fun of the kind that has made him so popular. You have heard him broadcast both these tunes on a Friday night. Worth every penny of the thirty! Another new Harry Roy disc worth getting is Parlophone R1939, with "Say It" and "Yes Sir, I Love Your Daughter"—the latter from the film "Hi-Diddle Diddle."

★(a) **Valencia**, (b) **The "Apache" Dance**, Massed Bands of Lew Stone, Alfredo Campoli and Don Rietto, 1s. 6d. **DECCA F5167**

You all know "Valencia!" Its years old, but when you hear it played by three first-rate bands together it sounds newer than ever. As I have said elsewhere, the record companies are putting out really good stuff. This is a typical example. This disc sounds well on my big radiogram. Try it on yours!

(a) **Without a Word** (w.), (b) **The Slump is Over** (march), Wal Berg and His Orch., 2s. 6d. **DECCA-POL P05106**

I don't know this band, sounds French though! Hardly what one would call modern rhythmic stuff, but nevertheless decidedly pleasant, mainly on account of its fine recording and tunefulness.

How the Cathode- ray Tube Works

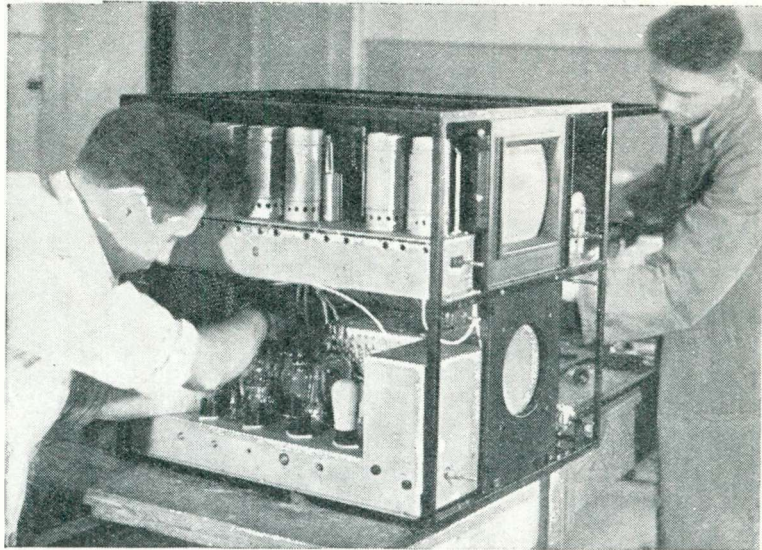

The latest Telefunken cathode-ray television receiver

MUCH has been written lately about the relative merits of various types of mechanical television devices. Very little is generally known, however, about the cathode-ray system which may oust all others when television becomes a more general form of home entertainment.

Perhaps, therefore, a few notes on the construction and action of

bunched together in the narrow part of the tube and the main connections are brought out to a four-pin valve base connector which is cemented to the end of the tube.

The separate elements are shown in Fig. 1. They are the filament *F*, in front of which is the shield *S* and the gun *G*. Between these and the screen are two pairs of deflector plates, V_1 and V_2 , and H_1 and H_2 .

2 volts, usually supplied by an accumulator or by a step-down transformer from A.C. mains. This will give rise to a stream of negatively charged particles or electrons, which are drawn to the gun, the latter being maintained at a high positive potential of about 750 to 1,000 volts.

This action is analogous to that of the filament and anode of a valve, which emits electrons from the filament which are drawn to the anode and give rise to anode current.

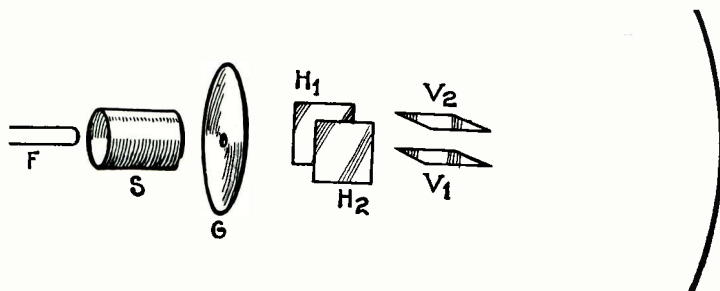

Fig. 1.—The separate elements of the Cathode-ray tube and their position relative to the screen

The Gun

If we examine the gun in the cathode-ray tube, however, we shall find that it consists of a metal disc which, unlike a valve anode, has a small hole punched in the middle.

Thus, some of the electrons which fly to the gun will not be arrested, but will pass through the hole and form an electron stream. This will impinge on the fluorescent screen and give rise to a faintly luminous spot. The intensity of this spot depends on the electron density of the beam. As the area of the hole is very small compared with that of the gun electrode, only a few of the electrons emitted from the filament will pass through as a beam (Fig. 2a).

The shield is introduced to concentrate the electrons from the filament about the centre of the gun and so ensure that a high pro-

the cathode-ray tube will enable you to read with much greater understanding any future articles that may appear on the subject.

The cathode-ray oscillograph is built into a pear-shaped glass tube about 15 in. long, which is nearly flat at the wide end and tapers down to a narrow tube of about $1\frac{1}{2}$ in. in diameter. The inside of the flat end is coated with a fluorescent material such as zinc silicate so as to form an almost opaque screen of whitish hue.

The electrode assembly is

The connections to these plates are brought out to separate terminals, fused in the glass of the tube.

Neglecting for the time being the function of the deflector plates, the action of the cathode-ray tube can be compared with that of an ordinary three-electrode valve. Whereas a valve is contained in an evacuated bulb, however, the cathode-ray tube has a small amount of helium introduced into the bulb to assist its action.

The filament *F* is heated to a dull red heat by a potential of

portion of the available electrons will pass through the hole. This will give rise to an electron beam of high density and consequently will ensure a well-defined spot on the

triode valve of the ordinary type.

Deflecting the Beam

The electron beam is capable of being deflected by a magnetic or

beam will be deflected in opposite directions at each half-cycle. The frequency of the change of direction will be equal to the frequency of the A.C. voltage applied. If this is above the speed of the persistence of vision the changes of direction will not be noticeable and the result will be a luminous line on the screen. Similarly, if an alternating potential is applied to the horizontal plates a horizontal line will be traced. The length of the line depends on the potential applied.

This briefly explains the action of the various electrodes of the cathode-ray oscillograph.

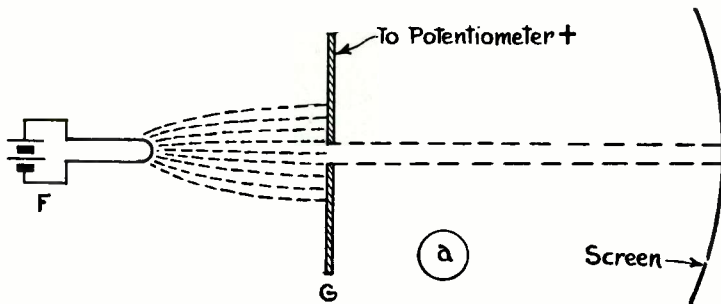

Fig. 2a.—Diagram showing how a portion of the electron stream passes through the gun

screen. You know that electrons, being negatively charged particles, are repelled by a negatively charged body. Thus it can be easily seen that if a cloud of electrons is passed through a negatively charged cylinder, they will be repelled on all sides and will concentrate themselves down the centre of the cylinder (see Fig. 2b).

The Action of the Shield

This is the function of the shield in the cathode-ray tube. It consists of a small metal cylinder situated axially along the line between the filament and the small hole in the gun. In order to concentrate the beam the shield is given a negative potential of about 100 volts, and as this voltage is rather critical it is usually made variable by means of a potentiometer. The slider of the potentiometer is set to give the

electrostatic field, and it is for this purpose that the two pairs of deflector plates are introduced. If, for instance, a battery is connected

The Tube in Television

It will be interesting briefly to consider the auxiliary apparatus necessary for the operation of the cathode-ray tube. The tube itself requires an H.T. supply like an

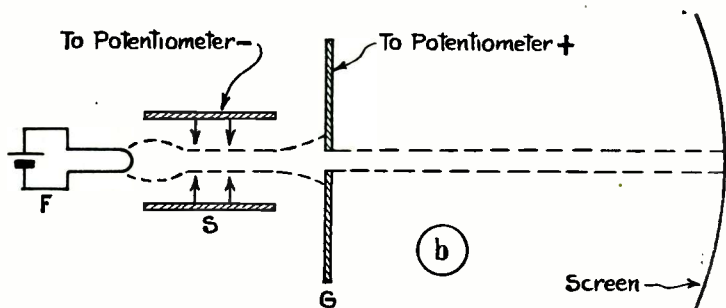

Fig. 2b.—Diagram showing the action of the shield

between the two vertical deflector plates V_1 and V_2 , the beam will be repelled by the negatively charged plate and attracted by the positive plate. Thus the beam will tend to

ordinary power valve only the voltage is higher, approximating 1,000 volts. To produce the line screen for television purposes two circuits called time bases are needed which are connected to the deflector plates of the tube. These circuits cause the spot to travel across the fluorescent screen rapidly and uniformly to generate the scanning lines. While the spot is travelling across the screen its intensity is varied in order to produce light and shade.

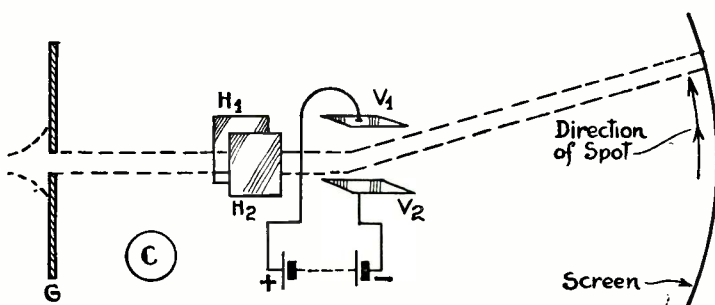

Fig. 2c.—The effect of applying a potential to the deflector plates is shown in this diagram

brightest spot on the screen. This action is known as "focusing" the spot.

The shield of the cathode-ray tube can be compared with the negatively biased grid of a

move between the plates from the negative to the positive. This will cause the spot to move across the screen (Fig. 2c). If, now, an alternating potential is applied between the plates H_1 and H_2 , the

This system of television is called "intensity modulation" since the beam is caused to alter its intensity as it traverses the screen. In "velocity modulation" the beam is caused to alter its speed of traverse continually as it moves along the line, and thus to give an impression of light and shade. The slower the travel of the beam the more intense is the illumination of the screen and vice versa.

S. R. W.

THE FUTURE of TELEVISION

Cathode-ray

or

Mechanical Systems?

By H. CORBISHLEY

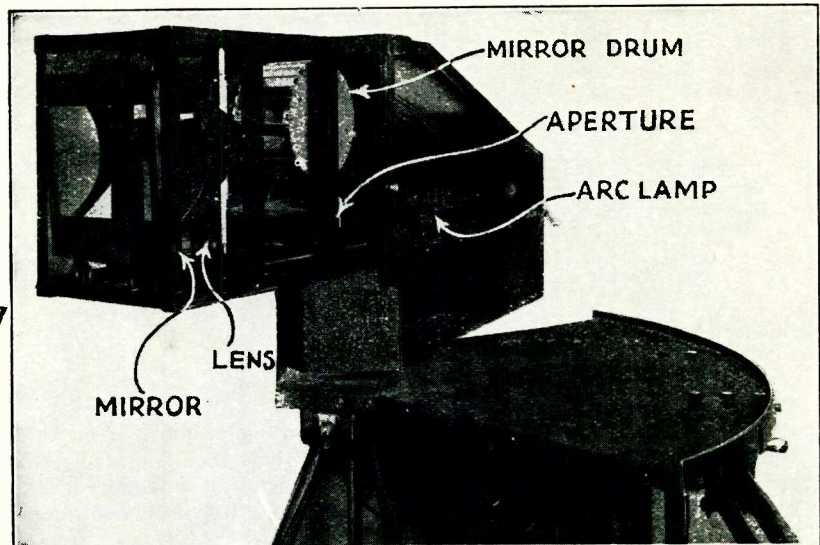

A mechanical transmitter scanner employing a mirror drum. This is the actual machine used for the B.B.C. transmissions

TELEVISION research workers are divided into two schools—one which pins its faith to the cathode-ray tube for the ultimate development of television, and the other which argues that the solution lies upon mechanical lines. It is to be admitted that of late the adherents of the cathode-ray tube have appeared to preponderate, but this may be because this system is of more recent introduction and

therefore perhaps is offering a wider and newer field for investigation at the present time. In this connection it is interesting to note that at the recent German Radio Exhibition, where a very considerable feature was made of television, there was only one mechanical system shown.

Further inquiry into this aspect of the position, however, revealed that although mechanical systems were this year, for the first time,

conspicuous by their absence, research work on mechanical systems was by no means dead, and it is confidently expected that the results of this research now being carried on will appear in due course.

Mechanical Transmitters

Before considering the relative advantages of the two methods, it will be as well to point out that all systems which are capable of transmitting actual images, as distinct from films, employ some kind of mechanical device for transmission. There is one exception, and this is the Iconoscope of Zworykin, but authentic details regarding the actual performance of this apparatus are not available.

It could be argued, therefore, that what is good enough at the transmitting end will be good enough for the receiver, and this reasoning seems perfectly sound. Some difficulties of a practical nature arise, however, in the construction of mechanical receiving apparatus of the high-definition type. High-definition transmitting scanners are of the simplest character, in fact in the majority of cases the simple disc is employed; but the proposition is a very different one compared with the ordinary scanning disc with which the amateur is acquainted. The holes are so

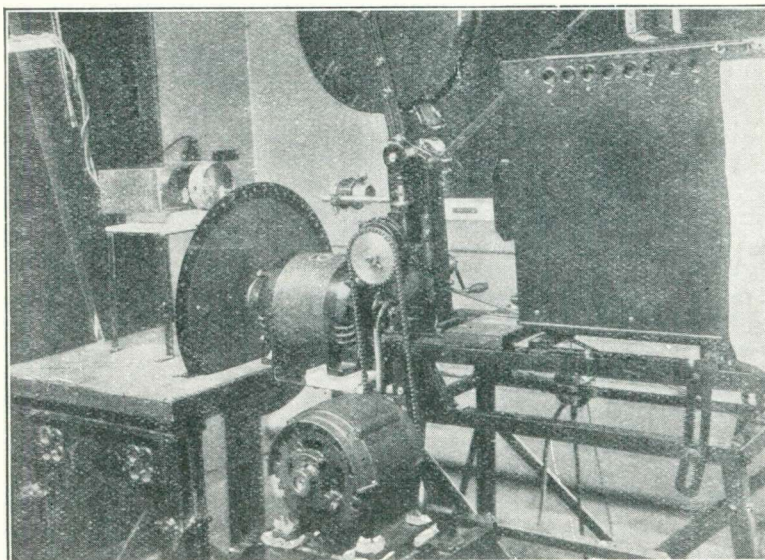

An experimental transmitter scanner for 90-line television using a perforated disc. The apparatus shown is for transmitting films

PARMEKO

DIRECT RECORDING SYSTEM

We shall be pleased to receive your enquiries for Direct Recording Apparatus, including :

- RECORDING MACHINES
- RECORDING AMPLIFIERS
- MICROPHONES
- SPECIAL RECORD BLANKS
- CUTTING NEEDLES, ETC.

PARTRIDGE & MEE Ltd.
AYLESTONE PARK, LEICESTER
 London Office : 74 New Oxford Street

"I'd like to try my hand at television..."

That is the comment we are often hearing from people who are interested in radio, but who are nervous of branching out into television.

TELEVISION has commenced a series of articles for the television beginner. This section deals with the technical side in such simple language as can be understood by any average radio home constructor.

Get a copy of the December issue of TELEVISION, now on sale, price 1s., and commence this beginners' course right away.

There are many other interesting features in the December issue—details of some of these are given below.

THESE ARE SOME OF THE CONTENTS OF THE DECEMBER "TELEVISION"

- Germany to Start a Television Service.
- The Simplest Cathode-ray Receiver—Building a Time Base.
- Television Made Easy—Special Section for the Beginner.
- Modern High-definition Transmission—The First Authoritative Details.
- Methods of Holding the Picture Steady.
- A 5- to 10-metre Ultra-short-wave Receiver. Full Constructional Details.
- The Reason for Multiple Pictures.
- New Ideas in Ultra-short-wave Reception.
- A Novel Method of Controlling Motor Speed.
- The Amplification of Photo-electric Currents.
- Synchronising from the Mains.
- Recent Developments, etc., etc.

TELEVISION

DECEMBER ISSUE

PRICE 1/-

UNIQUE



Prices do not apply in I.F.S.

ONLY "ATLAS" HAS THESE 6 OUTPUTS

THIS wonderful new "ATLAS" T10/30 is quite unique. It has no less than 6 TAPPED OUTPUTS. This ensures correct H.T. supply to any and every battery set—straight, super-het, class "B," and "Q.P.P." Not only is it the ideal mains unit for your present set, but it is also the ideal unit for every set you may buy or construct in the future. In addition to H.T. supply, it embodies a trickle-charger to keep your accumulator always fully charged.

FOR A.C. MAINS

H.T. Tappings: 60/80 v. (min. and max.), 50/90 v. (min., med., and max.), 120 v., and 150 v. Tapped Outputs: 10, 20, or 30 mA at 120 or 150 v. Trickle Charger: 2 v. at 0.5 amp. Westinghouse Rectifiers.

Guaranteed 12 months.

H.P. Terms.—10/- deposit and 8 monthly payments of 8/6 each.

Ask your dealer to-day for a demonstration.
 Other models from 39/6 cash or 10/- deposit.

ATLAS

MAINS UNITS

H. CLARKE & CO. (M/CR), LTD., Patricroft, Manchester.
 London: Bush House, W.C.2. Glasgow: G.E.S. Co., Ltd., 38 Oswald Street.
 I.F.S. Distributors: R. Marks, Ltd., 27 Upper Liffey Street, Dublin.

© 17

POST THIS COUPON NOW

Messrs. H. CLARKE & CO. (M/CR.), LTD., Patricroft, Manchester.
 Please send me FREE copy of Folder 95, telling me how to run my battery set from the mains.

NAME

ADDRESS

33/17

When replying to advertisements, please mention "Wireless Magazine"

small and the accuracy required is so great that discs of this type are very costly; also it has been found practically essential to run the discs *in vacuo* in order to reduce the air friction at high speeds necessary and prevent dust accumulating in the holes, conditions with which it would be



The Cossor portable mains oscillograph

difficult to comply in the home receiver.

Similar difficulties are present with other types of mechanical scanner. For example, the construction of a mirror drum for high definition and high picture frequency would in all probability be quite impracticable, and certainly so for home receivers where cost and driving powers are considerations. Because of these mechanical difficulties, it must not be taken for granted, however, that high-definition reception by mechanical methods is impracticable; already the solution of a line frequency of 120 has been found, and development is proceeding with 180 and 240 lines as the objectives.

Cathode-rays and Picture Size

The most obvious disadvantage of the cathode-ray system is the limit which the size of the cathode-ray tube imposes upon the size of the picture. This limit is due, of course, to the difficulty of

making tubes with a larger screen area than about twelve inches in diameter; in fact, the normal size of tube is much less than this. At the present time there seems to be no way of surmounting this difficulty, and the only way of obtaining a further increase of picture size is by the use of lenses to magnify the image and there are serious objections to this on account of the cost, the introduction of distortion, and the comparatively small amount of magnification that can be accomplished.

Picture size in the case of the home type of receiver is not of very great importance, though it is to be conceded that it is desirable that it be not less than about eighteen inches square, and this at the present juncture is no more than barely possible with the cathode-ray tube. Screen projection with the cathode-rays is out of the question, for the limit of the travel of the electron beam is the tube itself. The only method of obtaining a large picture is to make a film of the image as it appears on the end of the tube and then to project this.

From other points of view the cathode-ray system has much to commend it. The apparatus can be constructed so that maintenance work is negligible and operation almost automatic, two very desirable features in apparatus for home use, in fact, development will certainly make it possible to operate this class of receiver as easily as an ordinary wireless receiver.

Mechanical Scanning

Those who are opposed to mechanical systems have for their principal argument the contention that the light beam cannot be moved sufficiently rapidly by mechanical means for the production of high-definition pictures which have a frequency approximating that of cinema practice. The difficulties in this respect are very real, but, as was pointed out earlier, if such a method can be used for transmission there is no very obvious reason why a solution of the difficulties should not be found at the receiving end. Apart from this it must be remembered that the cinema which has now attained such a degree of perfection is entirely mechanical, though admittedly the speeds and therefore the difficulties associated with television are very much greater.

With mechanical systems the question of picture size is entirely bound up with that of the light value available which can be modulated. There are difficulties in this respect at the present time, and this is the factor which imposes a limit on the size of the pictures which can be projected. It is all a matter of how much light can be modulated. The value of this

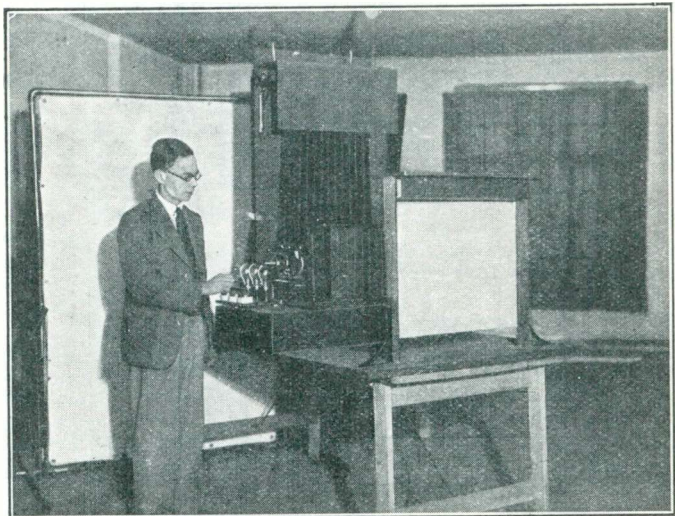

A mechanical receiver for screen projection of 120-line pictures. This is the Scophony apparatus

with current practice is somewhat small, and this explains why present-day pictures obtained with mechanical systems are small; the discovery of an efficient method of modulating large values of light

Continued on page 476

PILOT AUTHOR KITS

Exact to Specification

SEND US YOUR ENQUIRIES FOR EVERYTHING RADIO

Miscellaneous Components, Parts, Kits, Finished Receivers or Accessories for Cash or C.O.D. or H.P. on our own system of Easy Payments. Send us a list of your wants. We will quote you by return. C.O.D. orders value over 10/- sent carriage and post charges paid (GREAT BRITAIN ONLY). Hire Purchase Terms are NOT available to Irish and Overseas customers.

● **£4 BATTERY KIT 'A'** Author's Kit of first specified parts, including Ready-drilled 2 VALVER Polished Plywood Panel, and Baseboard, less valves, cabinet, and speaker. Cash or C.O.D. Carriage Paid £1 10 6. Deposit 5/-. Balance in 5 monthly payments of 6/-.

B.T.S. DROITWICH COIL 3/6

● **MODERN SUPER SENIOR KIT "A"** Author's Kit of first specified parts, including Ready-drilled Aluminium Chassis, for Receiver only, less valve, cabinet and speaker. Cash or C.O.D. **£9/5/0** Carriage Paid. Or 12 monthly payments of 17/-.

KIT 'B' As for Kit "A" but including set of 7 specified valves, less Cabinet and Speaker. Cash of C.O.D. Carriage Paid £13 12 6 or 12 monthly payments of 25/-.

KIT BITS You pay the Postman. We pay post charges on orders value over 10/- GREAT BRITAIN ONLY

- | | |
|---|---------|
| 1 Peto-Scott Ready-drilled Aluminium Chassis, 20 by 12 by 4 in. | £ s. d. |
| 1 Peto-Scott Ready-drilled Ebony Panel | 3 8 |
| 1 J.B. 40003-mfd. 9-gang Baby Gang Condenser with Arcuate Drive | 4 6 |
| 1 Varley 2-Gang coil unit | 16 3 |
| 3 Wearite I.F. Transformers Type O.T.2 | 1 2 0 |
| 1 Garrard Gramophone Motor, Type 30, with Automatic Stop | 1 2 6 |
| 1 Ediswan Minor Pick-up | 1 10 6 |
| 1 Atlas T10/30 Mains Unit | 1 1 0 |
| 1 Bulgin Duplex Needle-Cup | 3 9 6 |
| 1 Set of 7 specified valves | 2 0 |
| | 4 7 6 |

● **DE-LUXE KIT 'A'** Author's Kit of first specified parts, including Ready-drilled Aluminium Chassis, less valves, cabinet, and speaker. Cash or C.O.D. Carriage Paid £10 8 6. Or 12 monthly payments of 19/-.

PAUL D. TYER'S STENODE RECEIVER KIT

Described in September Issue
Cash or C.O.D. Carriage Paid, £11/3/6. Or 12 monthly payments of 2/3.

MAINS UNIT KIT

Cash or C.O.D. Carriage Paid, £4/5/6. Or 12 monthly payments of 7/3.

COMPLETE KIT

Cash or C.O.D. Carriage Paid, £20/18/6. Or 76/6 deposit and 11 monthly payments of 3/7.

NEW £6/6/0 BATTERY THREE

Described in October issue
KIT Comprising all specified components, including Peto-Scott ready-drilled Aluminium Chassis, less valves and cabinet. Cash or C.O.D. **£3-0-0**
Or 12 monthly payments of 5/6. Carriage Paid £1 1 0
Peto-Scott Universal Console Cabinet .. £0 15 0
Peto-Scott Universal Table Cabinet .. £1 5 0
Set of Specified Valves .. £1 5 0

BATTERY STENODE

Described in October Issue
KIT "A" Author's Kit of first specified parts, less valves and cabinet. Cash or C.O.D. **£9-13-6**
Or 12 monthly payments of 17/9. Carriage Paid.

KIT "B"—As for Kit "A" but including set of specified valves only. Cash or C.O.D. Carriage Paid, £12/6/6. Or 12 monthly payments of 22/6.

KIT "C"—As for Kit "A" but with set of specified valves and Peto-Scott Type Stenode "B" cabinet. Cash or C.O.D. Carriage Paid, £13/9/0. Or 12 monthly payments of 24/6.

PETO-SCOTT CO. LTD.

77 (W.M.12) CITY ROAD, LONDON, E.C.1
Telephone: Cle.kenwell 9406/7
West End Showrooms: 62 High Holborn, London, W.C.1
EST. 1919

AUDIO TRANSFORMER HISTORY

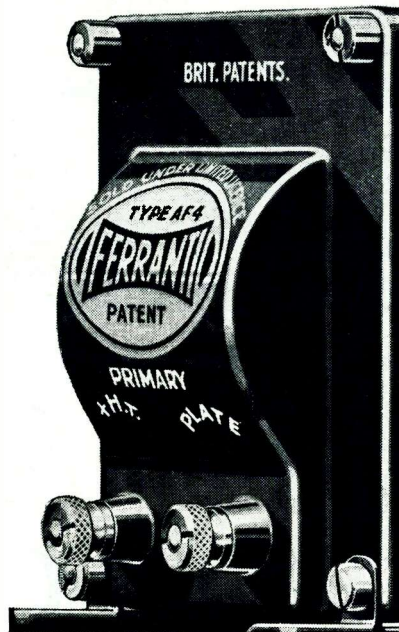

Thousands of Radio enthusiasts are to-day achieving excellent reproduction with sets incorporating a Ferranti Transformer bought over nine years ago. These Transformers were so good and so advanced in design that they still hold their own, and are in steady demand to-day. Where else can such Transformers be found? Their supremacy has been proved beyond question—even in the Tropics, in ship Radio installations, and by engineers everywhere, where good and lasting qualities are essential.

The AF4 Transformer illustrated was the 3rd type built by Ferranti, and is still in demand all over the world.

Type.	Ratio.	Inductance.	Price.
AF3	1/3.5	220/60 hys. 0.6 m/A.	25/-
AF4	1/3.5	45/20 hys. 0.5 m/A.	17/6
AF5	1/3.5	260/80 hys. 0.10 m/A.	30/-
AF6	1/7	85/50 hys. 0.6 m/A.	30/-
AF7	1/1.75	400/120 hys. 0.8 m/A.	30/-
AF8	1/3.5	45/20 hys. 0.6 m/A.	11/6
AF10	1/3	35/20 hys. 0.6 m/A.	8/6

Every Ferranti Transformer is guaranteed to give a performance within 5% of the standard published curve. Ferranti are the only Transformers so guaranteed.

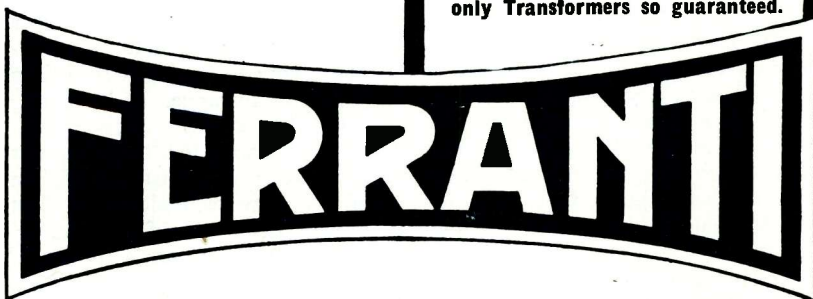

FERRANTI LTD., HOLLINWOOD, LANCASHIRE

CLIX Chassis Mounting Valveholders

Specified for the "DE LUXE D.C. THREE."

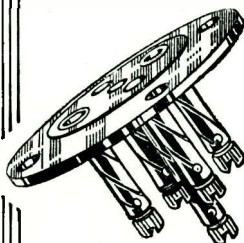

The designer prefers soldered connections, so, for this receiver you require the following Clix Valveholders (Without terminals).

THREE 5-PIN, without terminals, 6d. each. The designer also prefers Plug and Socket Contacts wherever possible, and has therefore specified Clix. You require:—

- EIGHT Clix Solid Plugs** at 2d. each.
- EIGHT Clix Insulated Sockets** at 2d. each.

Obtainable from ALL Dealers.

LECTRO LINX LTD.

79a Rochester Row, London, S.W.1.

It helps us if you mention "Wireless Magazine"



B.B.C. photo

How they sing at the B.B.C.—the Wireless Singers take things comfortably and sit round a table

By
**WHITAKER-
WILSON**

The B.B.C.'s Orchestras and Choruses

TO tell the story of how the B.B.C. Symphony Orchestra came into being means going back to the beginning of the century.

In those days there was very little good orchestral music in London at all. In fact there was only one regular orchestra of any note—the Queen's Hall Orchestra.

Sir Henry Wood had trained it since 1895 when the Proms first began. Musical people in London used to go to the Proms, which were not so popular then as now. Broadcasting has been a great thing for them.

Sir Henry told me that, years ago, people used to ask him where Queen's Hall was. When he told them it was up North Regent Street they used to look surprised and admit they had never been up there.

I think it was in the year 1904 that Sir Henry came to a definite decision regarding the system of permitting deputy players to attend concerts and rehearsals.

The deputy system permitted any member of the orchestra to accept an outside engagement if he wished, so long as he sent a competent player to take his place.

Abused in any form, however mild, this system became a nuisance. It meant that a new work requiring two or three special rehearsals might

be endangered in performance by a player absenting himself from rehearsal owing to having a recording session, for instance, and turning up at the concert unprepared. That is probably the extreme, but there were many instances when members only attended the last rehearsal and the performance.

From the conductor's point of view this sort of thing was hopeless. He never knew who was going to be there and who not. All he could be sure of was that the numbers were kept up.

Sir Henry determined to alter the arrangements. He refused to recognise the deputy system. Either he could have first call on members' time, or he would not go on.

The decision created something of a stir in musical circles at the time. I remember it perfectly. Sir Henry stood firm and consequently lost some of his best men whose work outside the orchestra did not admit of their subscribing to the new ruling.

These men, however, were not content to be out of things to that extent, and it is not surprising they

did something about it. They came together and, with others, formed the London Symphony Orchestra. The orchestra became so good that famous conductors like Richter, Nikisch and Weingartner were sufficiently interested to conduct it.

Not only so, but Sir Landon Ronald and Sir Thomas Beecham formed other orchestras. So that Sir Henry's little explosion stirred up musical London. During the War he kept the Proms going and, in a very wide sense, orchestral music in London looked up.

Then, you will remember, the B.B.C. took over the Proms in 1927. Things were none too good for any great orchestra just then, and the B.B.C. made its greatest move. In 1930 the orchestra was entirely reconditioned and became 114 strong. Now it boasts 119 players—120 with its conductor. For the Proms the B.B.C. uses about ninety of these players.

The full Symphony Orchestra makes up to 119 as follows. There are seventy-two stringed instru-



There was a young lady named Det
Owned a marvellous radio-set
But reception was bad—
It made her quite sad—
NOW it's soldered with
FLUXITE—you bet!

See that FLUXITE is always by you—in the house—garage—workshop—anywhere where simple speedy soldering is needed. Used for 30 years in government works and by the leading engineers and manufacturers. Of all Ironmongers—in tins. 4d., 8d., 1/4 and 2/8.

Ask to see the FLUXITE SMALL-SPACE SOLDERING SET—compact but substantial—complete with full instructions, 7/6. Ask also for Leaflet on CASE HARDENING STEEL and TEMPERING TOOLS with FLUXITE.

THE FLUXITE GUN

is a handy and economical tool that enables you to put the Fluxite where you want it on the soldering job, and is clean and simple to use. Nothing to remove—no mess—no trouble. Always READY FOR USE. Also used to project grease into grease cups, bearings, etc.—Just fill the nozzle portion—half fill the cup—put together and press as required. Price 1/6.



ALL MECHANICS WILL HAVE

FLUXITE

IT SIMPLIFIES ALL SOLDERING

Fluxite Ltd., (Dept. 382), Dragon Works, Bermondsey Street, S.E.1

FRANKLIN

FIXED RESISTANCES

Specified for Two Important Sets

► "The Modern Super Senior"

and

► "£4 Battery Two-Valver"

See the lists of components. These are the resistances used this year by leading set manufacturers. 1-watt values 6d., 2-watt values 1/6.

For best results also use Franklin TUBULAR CONDENSERS

ELECTROLYTIC CONDENSERS (Wet or Dry)
ELECTROLYTIC TUBULAR CONDENSERS

If obtainable local order direct from
FRANKLIN ELECTRIC CO. LTD.,
Gray House, 150 Charing Cross Road,
London, W.C.2.

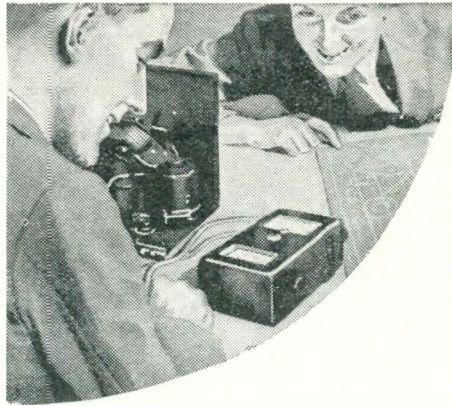

A whole night's job becomes but a few minutes' work with the Pifco ROTAMETER.

The new De-Luxe moving-coil model is amazingly accurate—it has a resistance of 200,000 ohms. The voltage scale registers up to 400 volts. In fact the ROTAMETER is a complete testing set in one handy-sized bakelite case.

Ask your dealer to show you one now, or write for new Pifco Testmeter Folder, describing all instruments, to PIFCO, LTD., SHUDEHILL, MANCHESTER, or 150 Charing Cross Road, London, W.C.2.

Good...that's found the fault...
what a good thing I bought myself a
PIFCO ROTAMETER



42/-

9 SEPARATE METERS IN ONE

ROTAMETER

- 1.—0-8 volts. For low-tension voltage test.
- 2.—0-30 volts. For grid-bias voltage test.
- 3.—0-250 volts. For high-tension voltage test.
- 4.—BATTERY TEST.
- 5.—0-20 m.a. For individual valve test.
- 6.—0-100 m.a. For testing current taken by total valves in set.
- 7.—0-250 m.a. For D.C. and rectified A.C.
- 8.—FILAMENT AND RESISTANCE TEST (4,000 ohms).
- 9.—Plug-in test for valves.

ROTAMETER-DE-LUXE

1. 0-5 volts.
2. 0-20 volts.
3. 0-100 volts.
4. 0-400 volts.
5. 0-10 milliamperes.
6. 0-50 milliamperes.
7. 0-250 milliamperes.
8. Resist/valve test.
9. Plug-in test for valves.

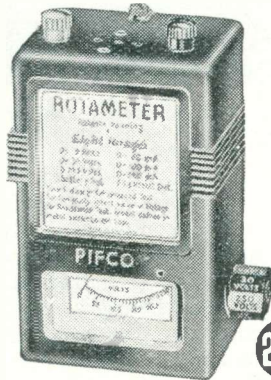

29/6

PIFCO ROTAMETERS

PIFCO ON THE SPOT WILL TRACE YOUR TROUBLES LIKE A SHOT

TELEVISION

December
NOW ON SALE

Principal Features:

- Germany to Start a Television Service.
- The Simplest Cathode-ray Receiver—Building a Time Base.
- Television Made Easy—Special Section for the Beginner.
- Modern High-definition Transmission—The First Authoritative Details.
- Methods of Holding the Picture Steady.
- A 5- to 10-metre Ultra-short-wave Receiver. Full Constructional Details.
- The Reason for Multiple Pictures.
- New Ideas in Ultra-short-wave Reception.
- A Novel Method of Controlling Meter Speed.
- The Amplification of Photo-electric Currents.
- Synchronising from the Mains.
- Recent Developments, etc., etc

NO RISK OF LIGHTNING
—NO EARTH REQUIRED
ABOLISHES ALL POLES AND
FITTINGS TO WALLS, ETC.
Gives all foreign stations as
clear as a bell with far greater
selectivity than you have
ever experienced before
with unbelievable
freedom from static
and other foreign
noises. Makes
listening in to
your wire-
less pro-



gramme
a pleasure
and stops un-
wanted stations
interfering and
"butting in." Only
one wire to your set.
"Oh, so easy," a child
can fix it. No broken limbs
replacing aerial after storms.
Price 7/6 with instructions.
Magnetic Earth Waves.

From all Wireless Stores, or—
SOUTHERN SUPPLY CO., LTD.,
86 Hampton Drive, Thornton Heath, Surrey.

Watkinson Ad

When replying to advertisements, please mention "Wireless Magazine"

ments: twenty first violins, sixteen seconds, fourteen violas, 12 'cellos, and ten double-basses.

The woodwind section amounts to twenty. There are five each of flutes, oboes, clarinets and bassoons.

The brass section also amounts to twenty: eight horns, five trumpets, six trombones, and a tuba. Two sets of tympani, also three players are required for the rest of the percussion, and finally there are two harps.

That is the Section A Orchestra, though the term is not generally used. The Section B Orchestra

might fit it for any regiment, but its spirit is not that of a military band at all. I consider the Wireless Military Band one of the most valuable in the B.B.C. system. Its tone is distinctive.

The Theatre Orchestra consists of about thirty members. It contains the strings usual to a symphony orchestra, but the rest of it breaks away from tradition and makes it suitable for the type of music it has to play. In addition to the regular wood, brass and percussion, it owns three saxophones and a member for playing guitar and banjo.

This is one of the hardest worked

have been divided up into four parts of ten members each, but a perfect balance for the microphone would not thereby have been gained.

The strength has been made up on the outside parts. There are thirteen sopranos and twelve basses, but the inside parts are eight contraltos and seven tenors.

The other sections of this chorus are made up much in the same way. The B Chorus has eight sopranos, six contraltos, five tenors, and seven basses. The C Chorus runs six, three, three, and four. The Revue Chorus has three sopranos but two each of the other parts.

The Male Voice Chorus is made up much on the same principle. It has four first tenors and five second basses—the extreme parts. On the other hand, its inside parts are three second tenors and the same number of first basses.

It is only when female voices are formed into a choir by themselves that the numbers are equal. The Ladies' Chorus has three first and second sopranos, and three first and second contraltos. That is really only another way of saying it has three each of sopranos, mezzo-sopranos, mezzo-contraltos and contraltos.

The harmonic construction of music written for female voices is so closely woven compared with music written for mixed voices that it is essential to have the voice-division equal.

The Sunday evening Epilogue is sung by a double quartet, but the 10.15 Daily Service is served by four separate quartets, each quartet taking over a certain number of services.

I very much doubt whether any foreign station can boast an organisation of this kind. The B.B.C. has never questioned its own needs. The formation of the Variety Orchestra was an example of this.

I should like to see a B.B.C. String Quartet: Arthur Catterall, Marie Wilson, Bernard Shore, Lauri Kennedy. They would make a good combination; Eugene Cruft could join them when a double-bass was wanted.

I wonder if anyone has thought of the idea. Catterall has a quartet of his own, now I come to think of it. No matter who plays in it, the idea of a permanent B.B.C. String Quartet is not a bad one, surely?



THE B.B.C.'S MOST POPULAR ORCHESTRA?
Nearly all listeners will agree that the Theatre Orchestra is the most entertaining of broadcast orchestras. Here they are seen waiting for the red light, with their conductor, Stanford Robinson, in a studio at Broadcasting House

consists of seventy-nine players. In this there are fifty-one stringed instruments. The woodwind comes to twelve, the brass eleven, one set of kettle drums and the same extra percussion, and one harp.

The Section C Orchestra is the smallest combination, made up from the 119 players. It has forty players only—seventeen strings, eight wood, nine brass (no tuba), tympani, and one harp. Section D is very much like B; seventy instead of seventy-nine. Section E has forty-nine players.

So much for the various sections of the B.B.C. Symphony Orchestra.

The Wireless Military Band is about thirty-five strong. It contains two flutes, two oboes, and two E-flat clarinets. There are eight B-flat clarinets, which are to the rest of the band what strings are to a symphony orchestra, four horns, three cornets, and two trumpets, three trombones, three basses, and a set of tympani.

I look upon this band as being military *in name only*. Its make-up

orchestras at Broadcasting House. Owing to the fact that it had more engagements than it could reasonably fulfil, the new Variety Orchestra was formed to take over the music-hall shows at St. George's Hall. This orchestra, at the time of writing, is gradually feeling its feet. It will soon be up to standard.

Finally, the Dance Orchestra. The present composition is two trumpets, a trombone, four saxophones (doubling clarinets), two violins, guitar, bass, piano, drums and effects.

Those, then, are the orchestras belonging to the B.B.C. The others you hear come from outside.

The choruses, too, are worth examining.

The B.B.C., or National, Chorus is a body of amateurs with a membership of about two hundred and fifty. At public symphony concerts at Queen's Hall this chorus is augmented by the members of the professional choruses.

Of these the full Wireless Chorus makes up to forty members. Note the division of voices. It might



● The London to Melbourne Air Race was won on accuracy—accuracy of workmanship, accuracy of navigation. Accuracy was a matter of life and death to Scott and Black.

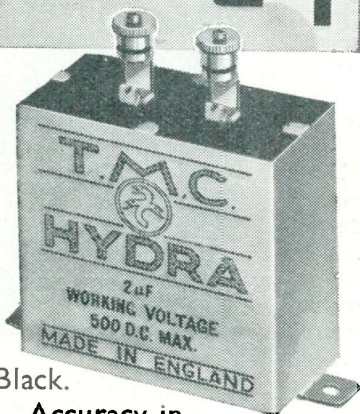

So with condensers. Accuracy in these vital components is not, it is true, a matter of life and death, but it is a matter of good and bad reception. You can make sure of getting accurate condensers by insisting on T.M.C.-HYDRA condensers.

T.M.C.
BRITISH MADE
HYDRA
CONDENSERS



Stringent testing of each individual unit at every stage of manufacture ensures the production of condensers that start accurate and stay accurate.

T.M.C.-HARWELL (SALES) Ltd
Britannia House, 233 Shaftesbury Avenue
London, W.C.2. (A few doors from New Oxford Street)
Telephone: Temple Bar 0055 (3 lines)

Made by TELEPHONE MANUFACTURING Co. Ltd.

IT'S DIFFERENT

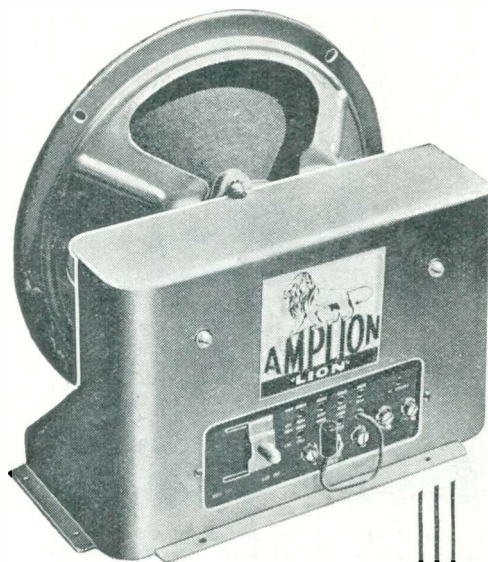

CONVINCING PRESS OPINIONS!

"Popular Wireless" says—

The whole design of the Amplion "Lion" is on advanced lines and is characteristically different from the general run. A veritable switchboard in miniature at the back of it at once evinces its versatility in use.

There are terminals for connecting an extension speaker and terminals for tone or volume control, if such are desired. A plug and numerous sockets enable accurate matching to be made with any output.

One of the most important points in its design is the provision of a Sealed Magnetic Gap. This is, we believe, an absolutely new departure. You probably all know how vitally vulnerable the gap of a moving-coil speaker is; you have seen dozens of tips and hints on how to remove dust and other foreign matter from this delicate area.

That it has been necessary to publicise such tips is complete proof of the weakness of normal M.C. speaker design. But in this latest Amplion "Lion" the gap is covered in (as it should be), and thus one more snag has been eliminated from radio.

It was at once apparent that the Amplion "Lion" had a bass response cleaner and more generally satisfactory than the average instrument in its price class. There was negligible resonance, and the high notes were there in full measure almost up to the practical limit of broadcasting.

This really is a fine production, and one which we have no hesitation in recommending to the attention of all readers who desire quality results without undue cost.

It is a first-class speaker, and we congratulate Messrs. Amplion on their achievement.

"Practical Wireless" says—

The sensitivity is of a very high order . . . high notes are reproduced with all their brilliancy, whilst the low notes are nice and full-bodied without being boomy.

FOR THE "DE LUXE D.C. THREE" Amplion "Triple-X" Energised M/C Speaker, price 35/-, is specified.

47/6
(7" CONE)

AMPLION

AMPLION (1932) LTD.

82-84 Rosoman Street, London, E.C.1

Advertisers like to know you "saw it in the 'Wireless Magazine'"

The Super Senior Modification

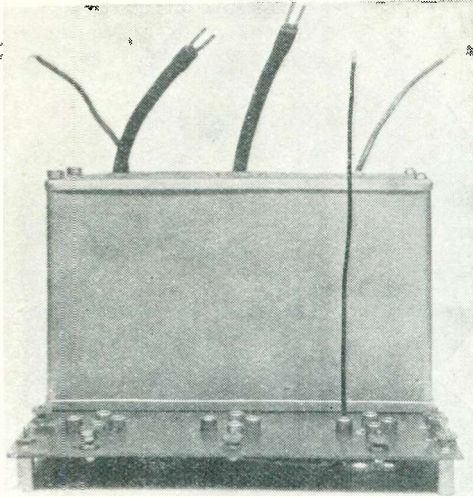

A general view of the Lewcos three-coil unit, showing the additional wire coming from the underside of the valve platform

LAST month when we described a new and up-to-date version of W. James' famous super-het, the Super Senior, we promised that this month we would show readers how to adapt and use the Lewcos three-coil unit, which was used in the original set.

Minimum of Trouble

We have arranged matters so that this can be done with the minimum of trouble—simply one or two wires to be removed, while the rest of the components "stay put."

First of all, several wires have to be left out. Of course, you realise that you no longer want the three four-pin valve holders, three intermediate-frequency coils with pig-tails and the three-way base shown in the design last month.

These are included in the Lewcos intermediate-frequency unit.

By removing these components you also have to omit wires No. 96, 59, 71, 73, 74, 34, 35, 27 and 28. The box will fit easily in the place of the components taken out.

Now as regards the box, you will see that you have to make a slight alteration to the wiring. Just tip your box upside down for a

moment, then a glance at the illustrations will show you what we have done.

The wire which originally went to the anode socket of the first detector valve has been removed from this socket. Solder on to this wire another length of 20-gauge tin copper, cover it with sleeving, drill a small hole through the bottom of the baseplate and make the wire long enough so that it will go to the top of the first detector valve. This leaves a blank socket. Connect a wire from this blank

socket to the terminal marked SG, and do not forget to cover it with sleeving.

Now about connecting this up. You will see from the drawing how to do this. The two flexible rubber-covered wires that come through the top of the can are connected to the anodes of the intermediate-frequency valves. The new wire, which you have just put on, goes, as we have already told you, to the top of the detector valve.

Looking at the unit with the valve holders at the front, the terminal marked L.T.+, on the right-hand side, is connected to wire No. 29.

Just beneath it is the L.T.—terminal, which is connected to the fixing bolt by means of wire No. 75. Wire No. 76 also goes to this same bolt. Terminal marked G1 has two wires connected to it—No. 77 and 78. The terminal marked SG is for the

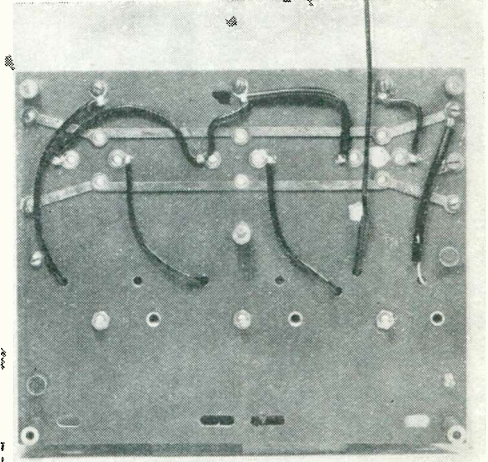

Constructors can easily follow the slight alteration made to the underside wiring of the Lewcos three-coil unit from this photograph

screen voltage. Flexible connection No. 104 goes to this.

Wire No. 43 goes to terminal marked G4, while the left-hand terminal is not used. There are two connections to the left-hand positive terminal—wires No. 25 and 26.

Flexible Leads

On the top of the can are two thin flexible connections. The left-hand one takes the place of wire No. 38 and goes to the top of the 2-microfarad fixed condenser and to wire No. 57.

Wire No. 17 is the other thin flexible connection and it goes to the P terminal on the oscillator valve holder.

We want to emphasise that it makes no difference to the results whatever intermediate-frequency arrangement is used. We have described the modification to take the Lewcos unit because many readers have this available.

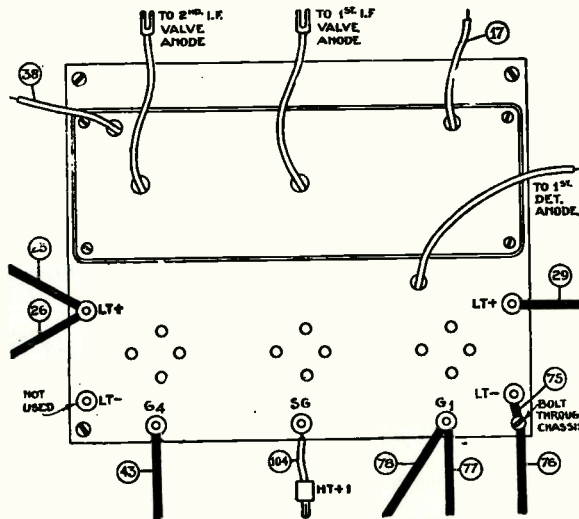

This drawing shows clearly the connections, with wire numbers, made to the Lewcos coil unit when it is used in the Modern Super Senior in place of separate coils and holders

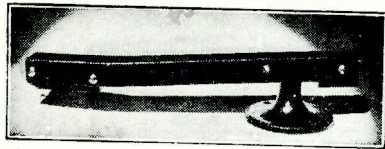

The Pick-Up of the Future

THE ROTHERMEL-BRUSH PIEZO-ELECTRIC PICK-UP

Acclaimed by the leading authorities as the greatest advance in design and performance that has ever been made, the Rothermel-Brush Piezo-Electric Pick-up gives a response of from 42 to 8,500 cycles with an output of 2 volts R.M.S. No other pick-up available can equal this performance. There is only 1½ oz. weight on the record, thus ensuring an entire absence of wear and tear. This new and revolutionary non-magnetic and non-resonant pick-up represents the finest value available and because of its outstanding performance has been adopted as standard equipment by R.G.D. and other prominent manufacturers of high-fidelity radio-gramophones.

**PRICE 42/-
COMPLETE**
Obtainable from all high-class dealers. If in difficulty, communicate with—

Write for complete lists featuring Rothermel-Brush Piezo-Electric Pick-ups, Speakers and Microphones, etc. Post free.

R.A.R. Rothermel LTD

(Dept. M) Rothermel House,
Canterbury Road, High Road, Kilburn, N.W.6.
Phone: Maida Vale 6066.

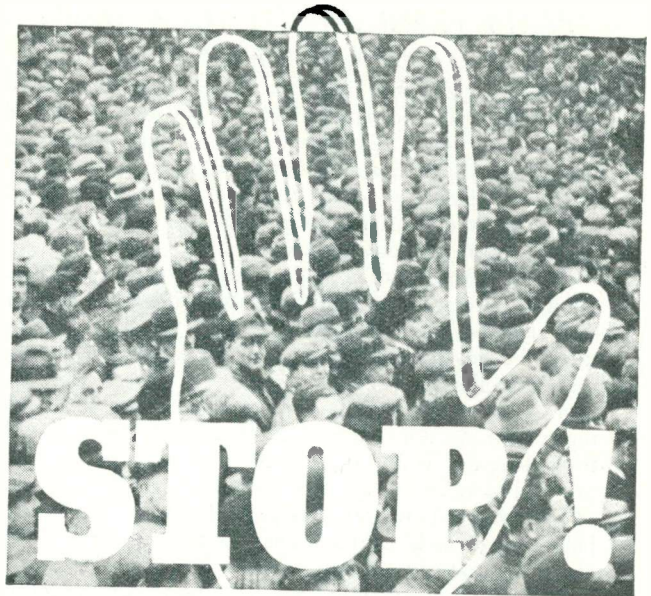

TUNGSRAM have
established as the price **3/9**
of the finest quality
valves in Britain



*No need to pay more
—unwise to pay less!*

Better tone, greater sensitivity, increased selectivity—any set, old or new, is enormously improved by fitting Tungstrams. Yet these amazing valves cost as little as 3/9. Only Tungstram's vast technical experience, advanced production methods, exclusive refinements of technique and construction and their wonderful new London factory have made this possible. With such resources at their disposal, it is not a matter of chance

that Tungstrams are so much better and cost so much less. It is logical and inevitable. Refit with Tungstram to-day.

HEAR THE DIFFERENCE—SAVE THE DIFFERENCE WITH

TUNGSRAM

BAR I U M V A L V E S

We will gladly send you the name of your local Tungstram dealer
TUNGSRAM ELECTRIC LAMP WORKS (GT. BRITAIN) LTD
72 OXFORD STREET, LONDON, W.1

Factories in London, Austria, Czechoslovakia, Hungary, Italy and Poland

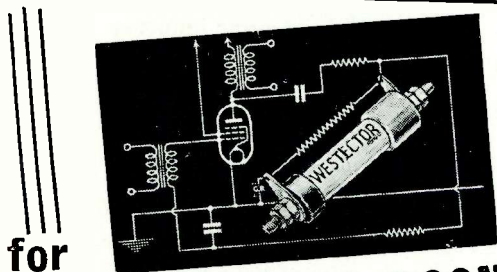

for

TRUE BATTERY ECONOMY

You need a reliable and efficient rectifier. One that will reduce your current consumption, yet, at the same time, introduce no distortion. Use the best none other is good enough. Use a Westinghouse Westector and halve your high-tension bill. The attached coupon and 3d. in stamps will bring you full particulars.

WESTINGHOUSE WESTECTORS

Full details of battery economy schemes please. 3d. in stamps enclosed.

Name

Address

W.M.12

THE WESTINGHOUSE BRAKE & SAXBY SIGNAL CO. LTD,
82, YORK ROAD, KING'S CROSS, LONDON, N.1.

Better service results from mentioning "Wireless Magazine" when writing to advertisers

PARTY PRANKS WITH YOUR RADIO

Continued from page 403

Shudder at suitable moments, and take hasty glances over your shoulder now and then. If your confederate in the other room has been following your efforts, via a pair of headphones and a loud-speaker, and reproduced the very necessary noises through his mike, the set and your loud-speaker, then you will have reduced your listeners to feeble wrecks.

The only snag here is that you will no doubt be called upon to open something in the nature of a tonic to calm their nerves. The confederate need not miss all the fun as he can get up to no end of pranks to produce the required effects.

A spot of dancing is always popular as it allows those who do not dance to have a little chinwag with their friends, while those who are more active can proceed to wear out the best carpet.

That reminds me, if it is possible to roll the carpet back then do so by all means as it is much nicer and also saves the pattern.

It is highly probable that a station can be found broadcasting dance music, but if conditions are not suitable for good reception then it is far better to use the radio gramophone.

This brings me to records, and I would most certainly advise you to include among your numbers those which are specially recorded for a Paul Jones and Musical Chairs. Both of these can cause endless fun. There are many novelties which you can introduce, but these must be governed by the space available and the number of guests.

For the thought-reading trick you want the microphone in the room with the party and connect it to a pair of headphones somewhere outside. Your confederate is blindfolded and pushed out into the cold, cold hall. As soon as the door is shut he, of course, bunks to the headphones and listens carefully.

You then request the party to think of something, an object, a number, or a saying, which you take care

to repeat carefully, just to make sure, you know, that they all think alike. When all the arguing has ceased you call in your fellow conspirator and, after making a few weird passes over his head, you ask him to think . . . think carefully now . . . and tell you what the party had in mind.

After a few seconds, during which he assumes a very thoughtful expression, if possible, he astounds one and all by telling them what had been selected, and so on.

These suggestions no doubt sound a trifle weak in cold, heartless print, but, believe me, if a little care and grey matter are expended, they can be made most effective and amusing. The various items must be adapted to meet your own requirements and space; similarly, you must bear in mind your guests and naturally select those jokes or pranks which you feel will appeal to them.

TRIODES VERSUS PENTODES

Continued from page 456

My conclusion is that the pentode can be made to give about the same low-frequency output as an equalised triode and normally a better higher frequency output with a considerably reduced grid swing, but at the expense of improved transformers and additional correction circuits.

Probably still better higher-frequency results could be obtained by redesigning loud-speakers so as to obtain the minimum self induction with a given number of active turns, possibly assisted by the use of fixed inductance neutralising windings.

The ideal way would be to build the loud-speaker winding so as to get a resistance and inductance suitable for the terminal condition of a low-pass filter with a cut off at a frequency arbitrarily chosen.

I feel that the matter of the shape of the current curves required for loud-speakers should be definitely settled, because at the present time the performance of loud-speakers is being arbitrarily arranged without due regard to the constants of the output circuit.

THE FUTURE OF TELEVISION

Continued from page 468

with reasonable power would give a very great impetus to mechanical television and probably place it right ahead of the cathode-ray system.

Two Lines of Approach

Although there is no indication of such an improvement being effected, it cannot be ruled out as an impossibility; there are two lines of approach, one modulating the light on production, the other the modulation of a constant source of light. Both these methods are used at the present time, but the efficiency in both cases is low.

No doubt some of the objections which are raised against mechanical systems have their foundation in the idea that oscillatory motion was to

be employed, as indeed was suggested in many of the earlier systems; however, experience has shown that the high speed movements necessary require rotary motion and this forms the basis in all successful systems. Rotary speeds of 10,000 revolutions per minute are quite practicable with carefully balanced apparatus, and these are ample for the purpose. It will be clear then that the weakness of the mechanical systems lies not so much in the mechanics of the apparatus, as in the electro-optical side, in other words the provision of a sufficient amount of modulated light. Cathode-ray systems also have their limitations in this respect, but probably it is not appreciated to such an extent because the real need for greater

intensity of light has not been felt because of the small size of the screen; increased size of screen, were this practicable, would provide another problem in the provision of a sufficient amount of light, and it is difficult to say upon what lines a solution of this would be found.

Summing Up

To sum up, it might be correct to say that the cathode-ray system of television is likely to provide the more immediate solution of the problem which will satisfy immediate needs, as for instance for the modest home type of receiver, but any approach to the standard of the cinema is likely to be upon mechanical lines unless some radically new principles are discovered.

'BEGINNERS' 2 VALVE!

**SPECIFIES
'362'
H.L.2. 3/6
M.E.2. 10/-**

362

The 362
RADIO VALVE CO. LTD.
STONEHAM ROAD
LONDON E.5.
Phone Clissold 1294

Ensure satisfaction by following the experts' specification!
H.L.2. 3/6. High Efficiency General-Purpose Valve. Higher mutual conductance than any other valve of its type.
M.E.2. 10/-. Pentode Type Output Valve. Large undistorted output from small H.T. voltage.
All 362 valves guaranteed 6 months. If unobtainable locally send P.O. direct to makers.

*The Perfect
Variable Resistance*
Specified for
**"THE MODERN
SUPER SENIOR"**

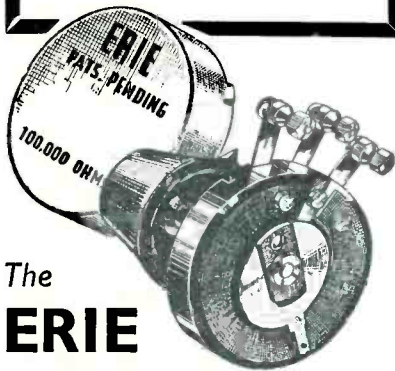

The
ERIE
VARIABLE RESISTANCE

Here is the variable resistance that will never develop faults—never fail or become noisy. The hard Erie resistance and nickel-silver contact ensure smooth efficiency for a life-time's use. If unobtainable locally, send direct.

FREE! The invaluable *Erie Service Instruction Booklet* gives helpful data on getting best results from resistors. Send for a free copy to-day!

THE RADIO RESISTOR CO., LTD.,
1, Golden Sq., Piccadilly Circus, London, W.1.

3/6

or with built-in mains 5/- switch

**Make your
set a part
of your
home**

Get an
OSBORN CABINET

MODEL 254
in Walnut, was specified for "The Lucerne Straight Four."
Price, 27/8.
Prices Carriage Paid U.K.

batteries. Mortised and tenoned throughout. Silk fabric baffleboard and baseboard included. Panel, above fret cut to your specification. Takes any type of gramophone motor, which we fit free if purchased from us. **PRICES:** Machined Kit of Parts, Oak, £2/0/0; Mahogany, £2/10/0; Walnut, £2/15/0. Assembled Ready to Polish: Oak, £2/16/0; Mahogany, £2/15/0; Walnut, £3/10/0. Assembled and Polished: Oak, £3/10/0; Mahogany, £4/0/0; Walnut, £4/5/0.



CHAS. A. OSBORN (Dept. W.M.), Regent Works, Arlington St., New North Rd., London, N.1. Tel.: Clerkenwell 5095.
Showrooms: 21 Essex Road, Islington, N.1. Tel.: Clerkenwell 5634.

WRITE FOR CATALOGUE

THE DESIGNER'S SPECIAL CHOICE IS VARLEY

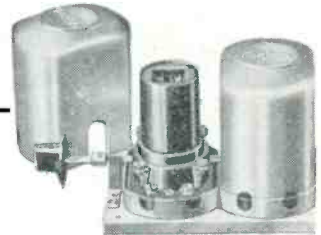

FOR THE
"MODERN SUPER SENIOR"

TWIN UNIT (BP50, BP51)
ganged complete £1.2.0

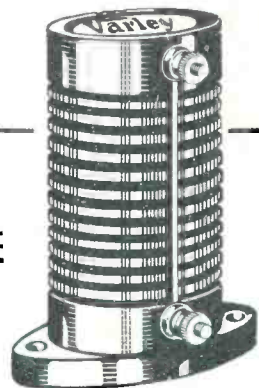

FOR THE
**"DE - LUXE
D.C.
THREE"**

JUNIOR H.F. CHOKE
List No. BP2 - - - 3/6

FOREMOST AS PIONEERS

Varley

(Proprietors: Oliver Pell Control Ltd)

Oliver Pell Control Ltd., Bloomfield Road, Woolwich, S.E.18. Tel.: Woolwich 234 S

Advertisers like to know you "saw it in the 'Wireless Magazine'"

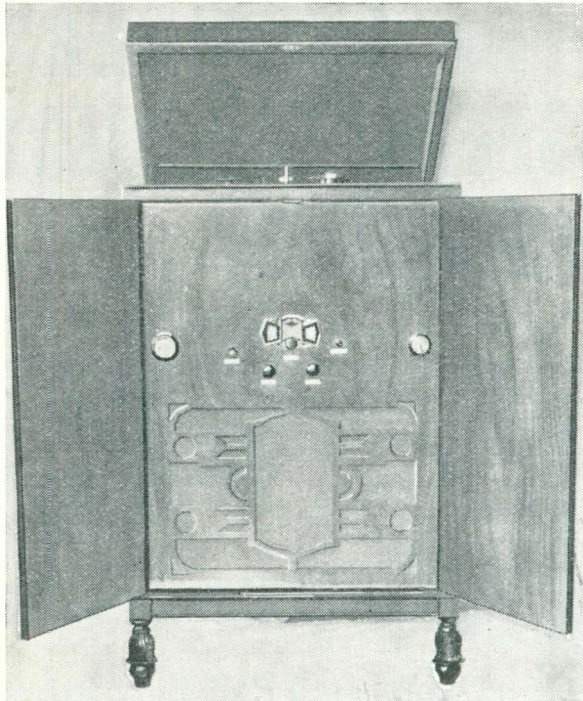

One of the largest and most successful "W.M." A.C. super-hets is the Seventy-seven Super, details of which appeared in the December, 1932, issue. This fine outfit was built by a Billesley, Birmingham, reader who reports very favourably on the set's outstanding performance

DESPITE its size the Goltone Nodaliser will be found to be a "giant" in action. This is what the manufacturers of this handy little component state. It is certainly most useful, as it provides a ready and accurate means of securing the electrical centre of low-tension secondaries.

Constructors who make use of A.C. mains will appreciate how vital this is if residual hum is to be reduced to an absolute minimum.

In these days of mass-produced transformers, it is not always possible to be certain that the centre-tap provided is at the dead electrical centre. With the Nodalizer, centre taps can be abolished, as it will provide the very necessary "hum balance" under the most exacting conditions.

The resistance value is 30 ohms, the list No. R23/143, while the price is only 2s. 6d.

We have just received a very interesting letter from a reader who signs himself G. L. Leigh. It is all about the All-wave Three, which we published in January of this year. The writer states that he is ten months late with his test report, but it appears that he was particularly unfortunate in obtaining all his supplies.

Colonial stations, not to mention a host of amateur transmitters, and one North African station.

Bearing in mind that these tests were made in August, we think that this is a pretty good show, and we shall look forward to receiving a much larger log now that the winter is with us. Thanks, G. G. L., for your letter; here's to many more additions to your log.

Another striking example of the application of electromagnetic waves to surgical cases is provided by the news that St. Bartholomew's Hos-

MICROVOLTS IN YOUR AERIAL

Continued from page 461

A more sensitive set can, as a rule, be used to its limit only late at night, when lights, trams, trains, etc., are at a minimum, and the strength of the transmitter fields is a maximum.

This figure will obviously vary greatly with the locality, the nature of the interference, and the wavelength of the wanted programme.

In a quiet neighbourhood, well away from electrical works, trams, etc., it may be possible to use a sensitivity of 20 to 50 microvolts with regularity; and in the country or extreme limits of town the super-

News from All Quarters

It appears that in spite of this being the first all-wave receiver Mr. Leigh has made, he has certainly been pulling the stations in from various parts of the globe. On the log he enclosed there are several American,

Russian and

hospital is experimenting in this direction. It is claimed that certain disorders will respond to this treatment without resorting to surgery. The effects can be controlled, so that the application can be directed to the affected part.

It is stated that the waves provide the quickest and safest method of dealing with certain lung affections, and the discovery is ranked as important as X-rays.

We are asked to point out that the price of the Mullard MB3 receiver, mentioned on page 305 of the November issue of "Wireless Magazine," includes batteries. This set is a three-valver employing the popular screen-grid, detector and output stage combination, and is marketed at £8 8s., complete with batteries.

Readers should note that the price of the Erie 1-megohm combined switch and potentiometer specified for the Modern Super Senior should be 5s., and not 4s. 6d. as mentioned.

sensitive set comes into its own, although even here it is seldom that the limit figure will be reached.

The unfortunate who lives in a city flat is at the other extreme, for lifts, fans, and the thousand-and-one other electrical necessities of civilisation may easily set a bar to a sensitivity of anything under 10,000 microvolts, or even more.

So to such a listener the only advantage of a big set is often the fact that it is fitted with a larger output valve or valves, and will thus give a greater and better quality output from the local stations. Late at night is his only chance of ether searching.

F. Y.

SET BUILDING IS EASIER IF YOU USE A

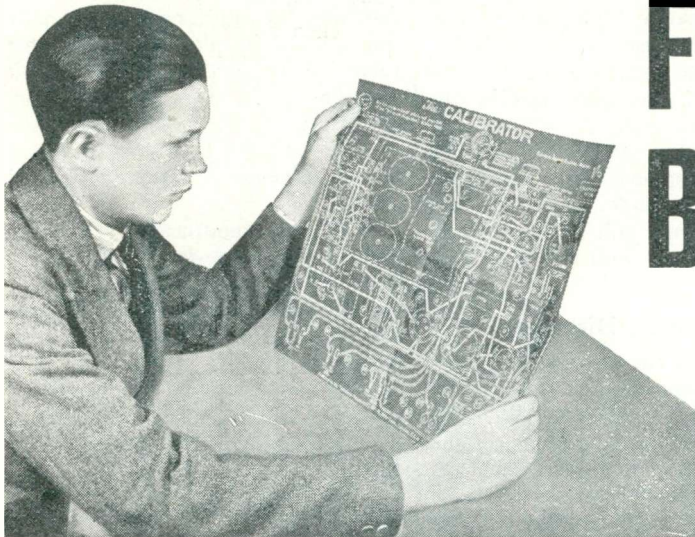

FULL-SIZE BLUEPRINT

Each blueprint shows the position of each component and every wire and makes construction a simple matter. Copies of "Wireless Magazine" and of "Amateur Wireless" containing descriptions of most of these sets can be obtained at 1s. 3d. and 4d., respectively, post paid. Index letters "A.W." refer to "Amateur Wireless" sets and "W.M." to "Wireless Magazine" sets. Send, preferably, a postal order (stamps over sixpence unacceptable) to "Wireless Magazine," Blueprint Dept., 58-61 Fetter Lane, London, E.C.4.

CRYSTAL SET (6d.)

- 1931 Crystal Set AW308
- 4 Station Crystal Set AW427

ONE-VALVE SETS (1s. each)

- Easy to Build One AW304
- Portable Short-wave One AW354
- B.B.C. One-valver AW387
- Short-wave One-valver AW429

TWO-VALVE SETS (1s. each)

- A Two for 7 Metres (D, Trans) WM295
- A.C. Quality Gem (D, Trans) WM312
- The Companionette (D, Pen-A.C./D.C.) WM358
- "W.M." Band-spread Short-waver (D, Pen) WM367

SPECIAL HALF-PRICE OFFER

Blueprints of the following "Wireless Magazine" sets described in this issue are obtainable at the special price, given below, if the coupon on last page is used before Dec. 31, 1934.

- Starting Radio for £4; simple battery two-valver, WM376 6d.
- De-luxe D.C. Three, WM377 6d.

- "A.W." Iron-core Two (D, Trans) AW395
- "A.W." Iron-core Two with Q.P.P. (SG, Trans) AW396
- Big Power Melody Two, with Lucerne Coils (SG, Trans) AW388A
- B.B.C. National Two, with Lucerne Coils (D, Trans) AW377A
- Lucerne Minor (Det, Pen) AW426
- Home Station A.C. 2 (D, Pen) AW374
- B.B.C. National Two (D, Trans) AW377
- Melody Ranger Two (D, Trans) AW388
- Consolectric Two (D, Pen) A.C. AW403
- Lucerne Minor (D, Pen.) AW426

THREE-VALVE SETS (1s. each)

- C.B. Three (D, LF, Class-B) WM333
- Duo-tuned Three (SG, D, Pen) WM341
- A.C. Transportable (SG, D, Pen) WM347
- All-wave Three (D, 2LF) WM348
- "W.M." 1934 Standard Three (SG, Det, Pen) WM351
- Emigrator (A.C. set: 14-500m.) (SG, D, Pen) WM352
- £3 3s. Three (SG, D, Trans) WM354
- Heptode Super Three (A.C. Super-het) WM359
- Iron-core Band-pass Three (SG, D, QP 21) WM362
- £6 6s. A.C./D.C. Three (SG, D, Pen) WM364
- All-wave Battery Three (SG, D, Pen) WM365
- 1935 £6 6s. Three (SG, D, RC.) WM371
- Pantofani A.C. Three (HF Pen., HF Pen. Det, Pentode output) WM374
- Home-lover's New All-electric 3 for A.C. mains (SG, D, Trans) AW383
- Our Up-to-the-Minute Three (SG, Westector, LF, Trans) AW384
- Class-B Three (D, Trans, class B) AW386
- A.C. Triodyne (SG, D, Pen) AW397
- Home-built Coil Three (SG, D, Trans) AW404
- Fan and Family Three (D, 2LF) AW410
- £5.5s. S.G.3 (SG, D, Trans) AW412

- 39/- Lucerne Ranger (SG, D, Trans) AW422
- Penta-quester (S.G., D, Pen) AW431

FOUR-VALVE SETS (1s. 6d. each)

- Calibrator (SG, D, RC, Trans) WM300
- Table Quad (SG, D, RC, Trans) WM303
- "Words and Music" Radiogram (2 SG, D, Trans) WM307
- "Words and Music" Radiogram de Luxe (SG, D, RC, Q.P.P.) WM307a
- Home Short-waver (SG, D, RC, Trans) WM311
- Calibrator de Luxe (SG, D, RC, Trans) WM316
- All-metal Four (2 SG, D, Pen-A. C. Mains) WM329
- Self-contained Four (SG, D, LF, Class B) WM331
- All-progress Four (Battery Super-het) WM335
- Merrymaker Super (A.C. Super-het) WM345
- 1934 A.C. Quadradyne (2SG, D, Pen) WM349
- Lucerne Straight four (SG, D, LF, Trans) WM350
- Universal Merrymaker (A.C./D.C. Super-het) WM356

- "A.C. Melody Ranger" (SG, D, RC, Trans) AW380
- "A.W." Ideal Four (2SG, D, Pen) AW402
- 2 H.F. Four (2 SG, D, Trans) AW421
- Lucerne Major (256 SG, Trans) AW433
- Crusaders' A.V.C. Four (SG, D, LF, Class-B) AW445

FIVE-VALVE SETS (1s. 6d. each)

- New Class-B Five (SG, D, LF, Class-B) WM340
- Class-B Quadradyne (2 SG, D, LF, Class-B) WM344
- "W.M." A.C. Stenode WM370
- Battery Stenode (Super-het) WM373
- James Short-wave Super (Super-het) AW328
- Simple Super (Super-het) AW343
- The Etherdyne (Super-het) AW406
- 1934 Century Super (Battery super-het) AW413

SIX-VALVE SETS (1s. 6d. each)

- 1932 Super 60 (Super-het) WM269
- 1932 A.C. Super 60 (A.C. Super-het) WM272
- "W.M." D.C. (Super-het) WM321
- James Class-B Super (Super-het with iron-coed coils) WM326
- Welcome Portable with class-B output stage WM325
- Connoisseurs' Super (A.C. Super-het) WM334
- James Super Straight Six (2 SG, D, LF, Push-pull) WM339
- Lucerne Super (battery super-het) WM355

SEVEN-VALVE SETS (1s. 6d. each)

- Super Senior (Super-het) WM256
- Seventy-seven Super (A.C. Super-het) WM305
- Q.P.P. Super 60 (Super-het) WM319
- Quartz-crystal Super (Short wave superhet) WM372
- Modern Super Senior (battery super-het) WM375

EIGHT-VALVE SET (1s. 6d.)

- "W.M." Radiogram Super (A.C. Super-het) WM366

PORTABLES (1s. 6d. each)

- Everybody's Portable (five-valve Super-het) WM291
- Welcome Portable (six-valve Super-het) WM322
- Spectrum Portable (SG, D, QP21) WM357
- "Two H.F." Portable (2SG, D, QP21) WM363
- Tyers' Portable (SG, D, 2LF) WM367
- General-purpose Portable (SG, D, RC, Trans) AW351

AMPLIFIERS (1s. each)

- 10-watt A.C. Amplifier WM360
- "W.M." Electric Gramophone (1s. 6d.) WM369
- Universal Push-pull Amplifier AW300
- "A.W." Record Player (LF, Push-pull) AW319
- Battery-operated Amplifier AW362
- "A.W.'s" Push-push Amplifier AW376
- Class-B Gramophone Amplifier AW391
- Universal A.C. Amplifier (3-valve) AW411
- Five Q.P.P. Output Circuits AW315

MISCELLANEOUS (1s. each)

- A.C. Short-wave Converter WM353
- "A.W." Trickle Charger AW351
- Experimenters' D.C. Mains Unit AW430
- Experimenters' A.C. Mains Unit AW432
- Add-on band-pass Unit AW359
- Plug-in Short-wave A aptor AW382

You can always rest assured that if you build your set with a "W.M." full-size blueprint, it will work first time and work well!

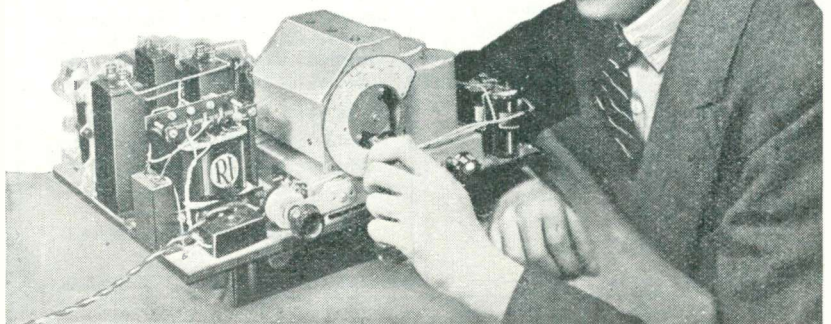

BLUEPRINT COUPON

Valid only until Dec. 31, 1934 (or until Jan. 31, 1935, for overseas readers)

FOR ONE BLUEPRINT ONLY

If you want a full-size blueprint of any ONE of the sets constructionally described in this issue for half price, cut out the above coupon and send it, together with a postal order, to Blueprint Department, WIRELESS MAGAZINE, 58-61 Fetter Lane, London, E.C.4.

This coupon is valid for a blueprint of any ONE only of the following sets at the prices indicated :—

STARTING RADIO FOR £4 (page 430), No. WM376, price 6d., post free.

DE-LUXE D.C. THREE (page 396), No. WM377, price 6d., post free.

INFORMATION COUPON

Valid only until Dec. 31, 1934 (or until Jan. 31, 1935, for overseas readers)

If you want to ask any questions, cut out the above coupon and send it, together with a postal order for 1s. and stamped addressed envelope, to the Information Bureau, WIRELESS MAGAZINE, 58-61 Fetter Lane, London, E.C.4.

Note that not more than two questions may be asked at a time and that queries should be written on one side of the paper only.

Under no circumstances can questions be answered personally or by telephone. All inquiries must be made by letter so that every reader gets exactly the same treatment.

Alterations to blueprints or special designs cannot be undertaken : nor can readers' sets or components be tested.

If you want advice on buying a set, a stamped addressed envelope only (without coupon or fee) should be sent to the Set Selection Bureau, WIRELESS MAGAZINE, 58-61 Fetter Lane, London, E.C.4.

CURING CAR-MADE STATIC

Continued from page 442

A troublesome high-pitched hum seemed to suggest slight instability, so a complete re-arrangement of this circuit was made, with considerable improvement.

Not only was the hum reduced to an inoffensive level, but the interference from cars was also less severe, although still strong enough to be unpleasant with full amplification.

Interesting Discovery

But while a car was standing outside the house with the engine running a very interesting discovery was made. The sparking of the magneto could still be clearly heard with the aerial disconnected!

Obviously then, as the receiver itself was only separated from the "transmitter" by a few feet, the best part of the interference was being picked up by the coils and wiring.

So some kind of screening had to be adopted, bearing in mind that while trying to exclude the unwanted

static an entry must be left for the wanted signal.

After various experiments in this direction, the interference was finally side-tracked by placing the detector valve, coils and all grid-circuit components in an aluminium box, and running the wire from lead-in tube to the set through screened flexible sleeving earthed at several points.

With these modifications, the disturbance is now too small to be troublesome and one can enjoy an uninterrupted programme. It was not considered advisable to screen the aerial lead-in, but with a very sensitive set it may be necessary.

INDEX TO ADVERTISERS

	Page
A	
Amplion (1932) Ltd.	473
Automatic Coil Winder Co., Ltd.	391
B	
British Inst. of Eng. Tech.
Brookes Instrument Co., Ltd.
Bulgin, A. F., & Co., Ltd.
C	
Clarke, H., & Co. (Micr.), Ltd. Cover iv, 467	
D	
Drydex
E	
Ever Ready Co., Ltd.
Exide
F	
Ferranti, Ltd.	469
Fluxite, Ltd.	471
Franklin Electric Co., Ltd.	471
G	
General Electric Co., Ltd. Cover ii, 387	
Gramophone Co., Ltd., The	392
Gramphon Reproducers Ltd.
H	
High Vacuum Valve Co., Ltd.
J	
Jackson Bros.	389
K	
Kolster Brandes, Ltd.
Keates & Co.
L	
Lectro Linx, Ltd.	469
Lyons, Claude, Ltd.
M	
Marconiphone Co., Ltd.	391
McMichael Radio, Ltd.
Melford Radio
Marluke Ltd.
O	
Osborne, Chas.	477
Ostar Ganz	390
P	
Partridge & Mee, Ltd.	467
Pertrix, Ltd.
Peto Scott, Ltd.	469
Pifco	471
R	
Regent Fittings
Radio Resistor Co.	477
Rothermel Corpn.	475
S	
Scott-Sessions & Co., Ltd.,	480
Stratton & Co.
Siemens Bros.
Southern Supply Co.	471
Smith (M/A), Ltd.	389
T	
Telegraph Condenser Co., Ltd.
Telephone Mfg. Co., Ltd.	473
362 Valve Co. Ltd.	477
"Television"	467
Tungram Electric Lamp Works (G.B.), Ltd.	475
V	
Varley (Oliver Pell Control, Ltd.)	477
W	
Westinghouse Brake & Saxby Signal Co., Ltd.	475
Wright & Weaire, Ltd.



for
Repairs - Rebuilding
Overhauls to all "Wireless Magazine" Sets
and to all
Commercial Sets

OUTSIDE SERVICING. Engineers sent or sets collected immediately in London and 40 miles around.

★ It costs no more in the end to have your set properly examined and repaired by Scott Sessions' qualified radio engineers. Send your set or 'phone now to

SCOTT-SESSIONS & CO.,
Radio Engineers and Consultants,
Muswell Hill, London, N.10.
Contractors to H.M. Govt. Depts., etc., etc.

Telephone: **TUDOR 4101**
(2 lines)

FULL DETAILS of **ENGLISH** PROGRAMMES from TWELVE CONTINENTAL STATIONS

Every week RADIO PICTORIAL devotes seven pages in giving full details of the English-speaking programmes from Continental stations for the coming week.

These programmes are exclusive to RADIO PICTORIAL.

RADIO PICTORIAL always contains forty pages revealing in pictures and in words the latest news and gossip about radio stars and well-known personalities of the microphone.

RADIO PICTORIAL appears every Friday and is sold by all newsagents and bookstalls—price 3d.

RADIO PICTORIAL



LISTEN TO THE "RADIO PICTORIAL" CONCERTS FROM
RADIO NORMANDY AND PARIS (POSTE PARISIEN)

Full details of Programmes etc. in the current issue.

40 PAGES EVERY FRIDAY - PRICE 3d.

THIS IS THE ONLY RECEIVER

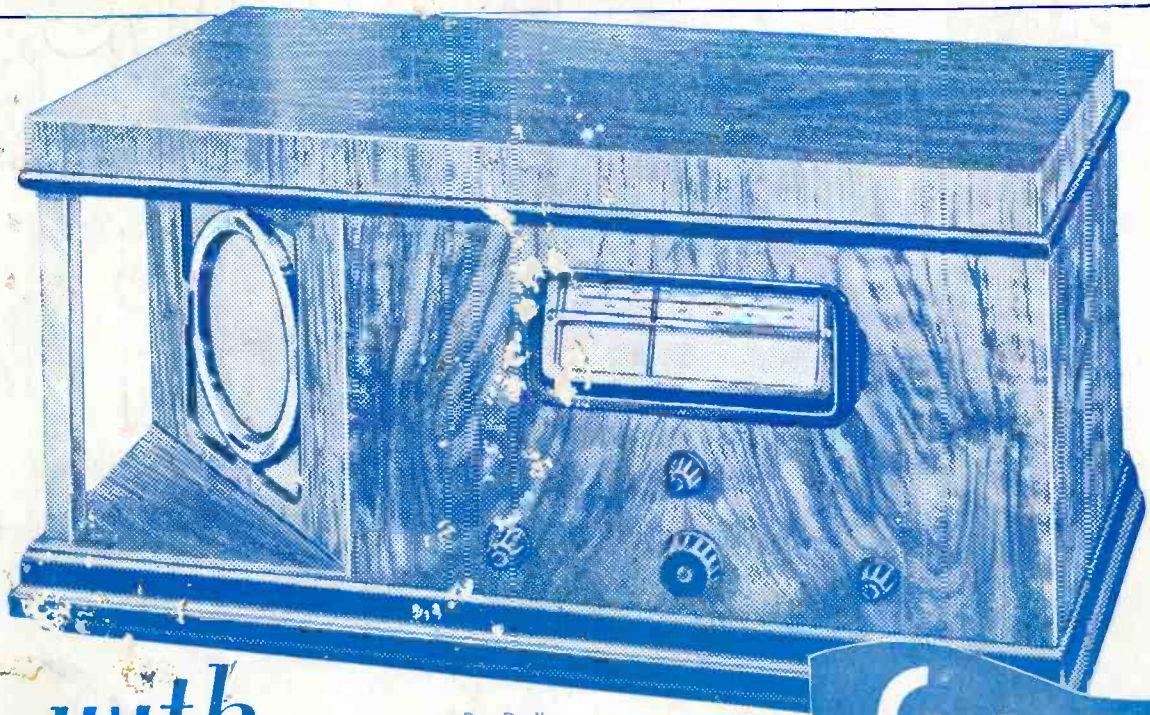

with **SPECTRUM TUNING-TILTING DIAL**

Pat. Pending

and this

£14-14
CASH PRICE

Masterpiece of Cabinet Craftsmanship!

NO other receiver in the world gives such utterly perfect performance, such purity of tone PLUS . . . these 3 VITAL EXTRAS.

"SPECTRUM TUNING," the simplest and only certain station identification yet devised. The TILTING DIAL is the only one in the world. It gives perfect readings at a glance from any tuning position. No peering and no stooping.

The "ATLAS" CABINET is the supreme triumph of the designer's and craftsman's art—a perfect blend of richly grained walnut, ebony and chromium—and an asset to any room.

No wonder the "ATLAS 7-5-8" was the sensation of Olympia. Remember that these features are exclusive to "ATLAS." That is why you must INSIST on "ATLAS." Ask your dealer for a FREE demonstration today.

Exclusive to the **ATLAS**

POST THIS COUPON NOW

Messrs. H. Clarke & Co. (M/cr.) Ltd.
Patricroft, Manchester.

Please send me full details of the wonderful new
"ATLAS 7-5-8" Set—the Super Superhet.

Name

Address

33/12

7-5-8

SUPER-SUPERHET

H. Clarke & Co. (M/cr.) Ltd., Patricroft, Manchester. London: Bush House, W.C.2. Glasgow: G.E.S. Co. Ltd., 38 Oswald Street. I.F.S. Distributors: R. Marks Ltd., 27 Upper Lishey Street, Dublin.

SPECIFICATION 7 stages, 5 valves, 8 junctions. For A.C. mains. Moving Coil Speaker, Band-Pass Tuning, Full Automatic Volume Control, Tone-Control, Noise Suppressor, Self-contained Aerial, Sockets for Pick-Up and Extra Speaker. Guaranteed for 12 months. H.P. Terms 12/6d. deposit and 12 monthly payments of 25/- each. CASH £14. 14s. od. Prices do not apply to I.F.S.